

2020

**MAKE X**

**MAKE X**

Intelligent Innovator  
Arena Assembly Instructions

智造大师场地

**搭建步骤图**

(Quick Guide)  
快速指南

P02 Intelligent Innovator  
Arena Assembly Instructions  
智造大师完整场地搭建步骤图

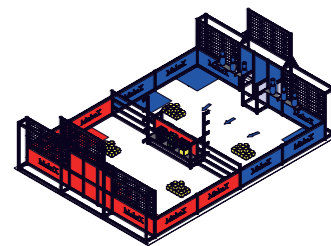

P38 Intelligent Innovator Practice  
Arena Assembly Instructions  
智造大师练习场地搭建步骤图

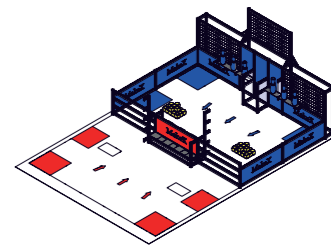

# Intelligent Innovator Arena Assembly Instructions 智造大师完整场地 搭建步骤图

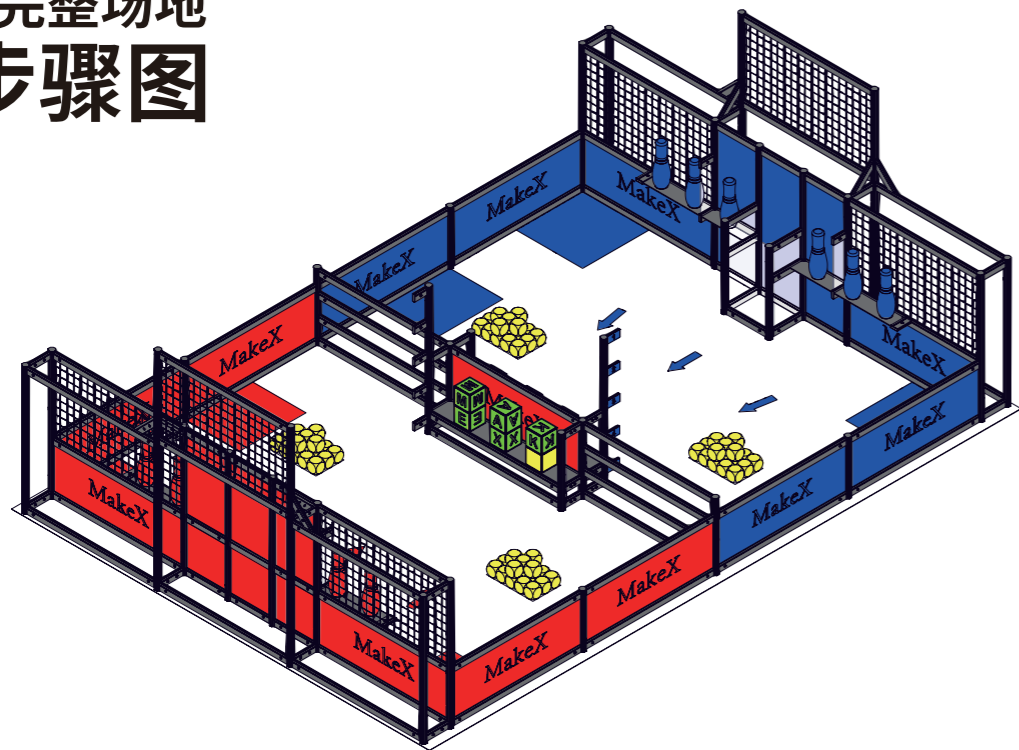























02

## Parts List物品清单

Actual amount might vary according to the competition guide  
(实际用量根据不同比赛规则调整)

03

4×	Octagonal Pillar 400 八棱柱400		16×	Flat Beam 160 扁铝160		8×	Flat Beam Lock 45°-Right 右卡锁	
6×	Octagonal Pillar 500 八棱柱500		12×	Flat Beam 220 扁铝220		72×	Octagonal Pillar Cover 八棱柱封盖	
8×	Octagonal Pillar 600 八棱柱600		18×	Flat Beam 293 扁铝293		22×	Flat Beam Cover 扁铝封盖	
22×	Octagonal Pillar 960 八棱柱960		56×	Flat Beam 960 扁铝960		6×	Metal Net 铁网	
18×	Flat Beam 92 扁铝92		8×	Flat Beam 45° 斜扁铝		6×	MakeX Board Red&Black 红黑护栏板	
4×	Flat Beam 104 扁铝104		250×	Flat Beam Lock 三卡锁		6×	MakeX Board Blue&Black 蓝黑护栏板	
12×	Flat Beam 120 扁铝120		8×	Flat Beam Lock 45°-Left 左卡锁		1×	PVC Board Mix 红黑蓝黑护栏板	

- |    |                                      |  |    |                              |   |     |                            |   |
|----|--------------------------------------|--|----|------------------------------|---|-----|----------------------------|---|
| 1× | Mat<br>喷绘                            |   | 2× | Board C2 Blue&Black<br>蓝黑板C2 |  | 2×  | Acrylic Board C3<br>亚克力板C3 |  |
| 6× | Bottle Red&Black<br>红黑保龄球瓶           |   | 2× | Board C2 Red&Black<br>红黑板C2  |  | 4×  | Acrylic Board C4<br>亚克力板C4 |  |
| 6× | Bottle Blue&Black<br>蓝黑保龄球瓶          |   | 1× | Board C3 Blue&Black<br>蓝黑板C3 |  | 80× | Small Cube<br>小方块          |  |
| 4× | Board 1<br>木板1                       |   | 1× | Board C3 Red&Black<br>红黑板C3  |  | 12× | 120mm Cube<br>120mm方块      |  |
| 4× | Board 2<br>木板2                       |   | 2× | PVC Board C4<br>PVC板C4       |  | 3×  | 扳手<br>HEX Allen Key        |  |
| 2× | Board C1 Blue&Black<br>蓝黑板C1         |   | 4× | Acrylic Board C1<br>亚克力板C1   |  | 10× | Cube Sticker<br>方块贴纸       |  |
| 2× | Board C1 Red&Black<br>红黑板C1          |   | 4× | Acrylic Board C2<br>亚克力板C2   |  | 1x  | Flat Beam Sticker<br>扁铝贴纸  |  |
| 4× | Octagonal Pillar Connector<br>八棱柱接驳条 |  |    |                              |   |     |                            |   |

## Assembly Preparation 初始搭建

### Octagonal Pillar Cover Assembly (Bottom) / 安装底端封盖

- |   |                                      |
|---|--------------------------------------|
|  | Octagonal Pillar Cover<br>八棱柱封盖 (22) |
|  | Octagonal Pillar 960<br>八棱柱960 (22)  |



## Assembly Preparation 初始搭建

Octagonal Pillar Cover Assembly (Bottom) / 安装底端封盖

06



Octagonal Pillar Cover  
八棱柱封盖 (4)



Octagonal Pillar 600  
八棱柱600 (4)

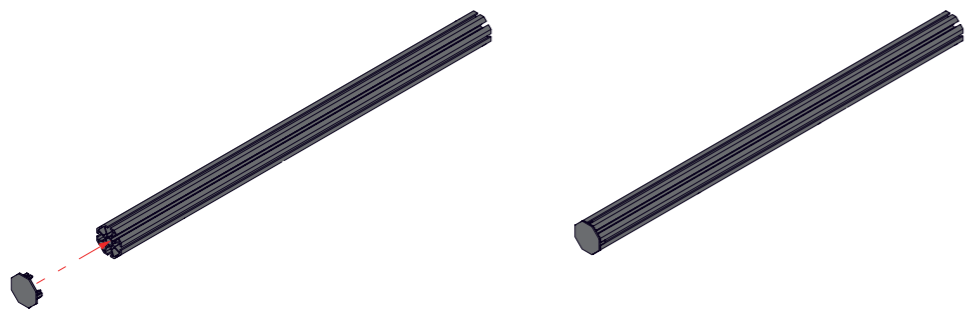

## Assembly Preparation 初始搭建

Octagonal Pillar Cover Assembly (Bottom) / 安装底端封盖

07



Octagonal Pillar Cover  
八棱柱封盖 (10)



Octagonal Pillar 500  
八棱柱500 (6)



Octagonal Pillar 400  
八棱柱400 (4)



## Assembly Preparation 初始搭建

### Flat Beam Lock Assembly/安装三卡锁

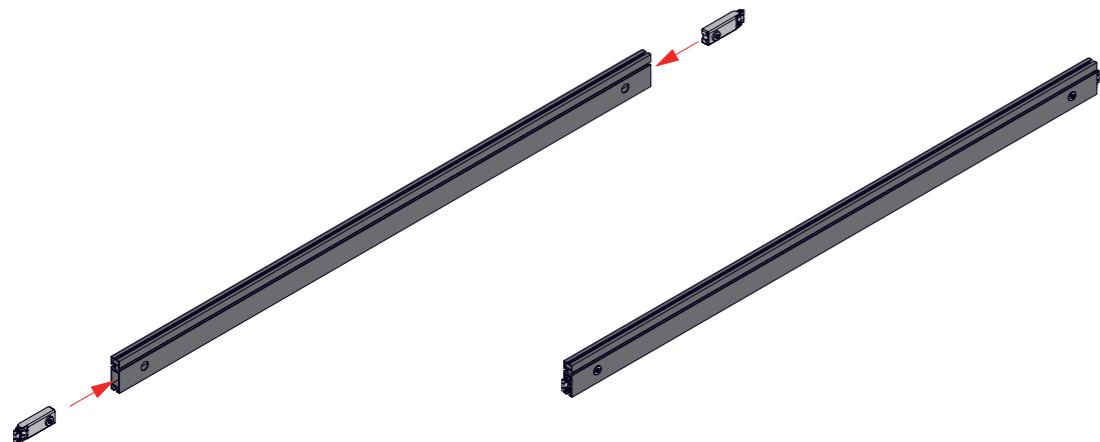

08

## Assembly Preparation 初始搭建

### Flat Beam Lock Assembly/安装三卡锁

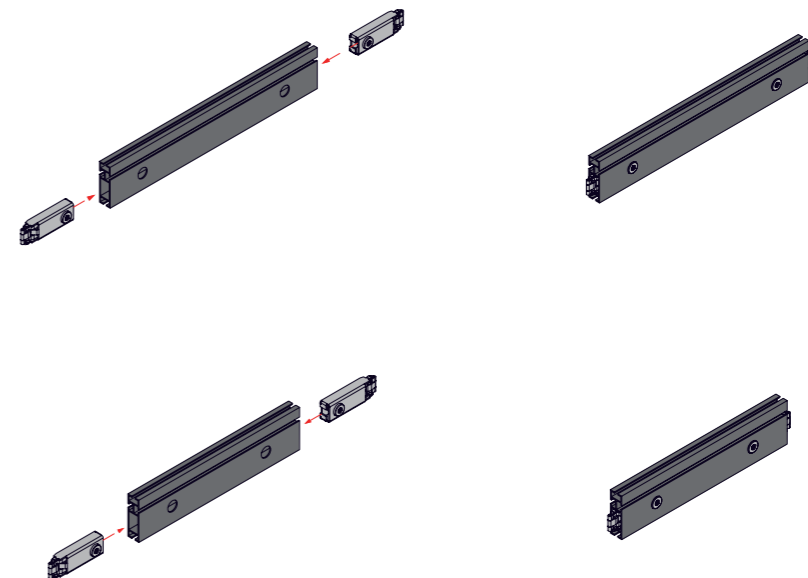

09

## Assembly Preparation 初始搭建

### Flat Beam Lock Assembly/安装三卡锁

10

 Flat Beam 160  
扁铝160 (16)

 Flat Beam 120  
扁铝120 (12)

 Flat Beam Lock  
三卡锁 (56)

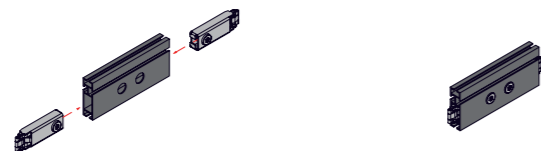
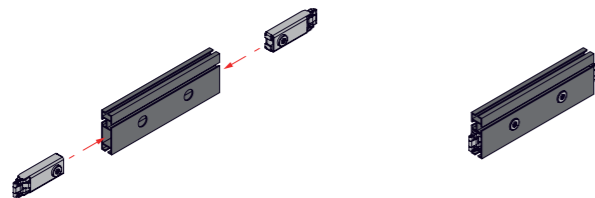

## Assembly Preparation 初始搭建

### Flat Beam Lock Assembly/安装三卡锁

11

 Flat Beam Cover  
扁铝封盖 (22)

 Flat Beam 92  
扁铝92 (18)

 Flat Beam 104  
扁铝104 (4)

 Flat Beam Lock  
三卡锁 (22)



## Assembly Preparation 初始搭建

### Flat Beam Sticker Assembly/安装扁铝贴纸



Flat Beam Sticker  
扁铝贴纸 (1)



Flat Beam 92 with Lock  
带三卡锁扁铝92 (10)

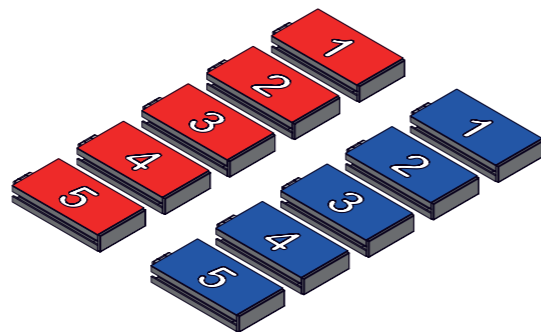
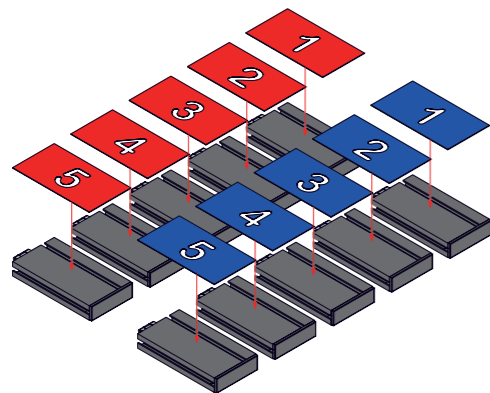

12

## Assembly Preparation 初始搭建

### Flat Beam Lock Assembly/安装斜卡锁



Flat Beam 45°  
斜扁铝 (8)



Flat Beam Lock 45°-Left  
左卡锁 (8)



Flat Beam Lock 45°-Right  
右卡锁 (8)



13



## Assembly Preparation 初始搭建

14

### Yellow Cube Sticker Assembly/安装EVA贴纸

-  Cube Sticker  
方块贴纸 (10)
-  120mm Cube  
120mm方块 (12)

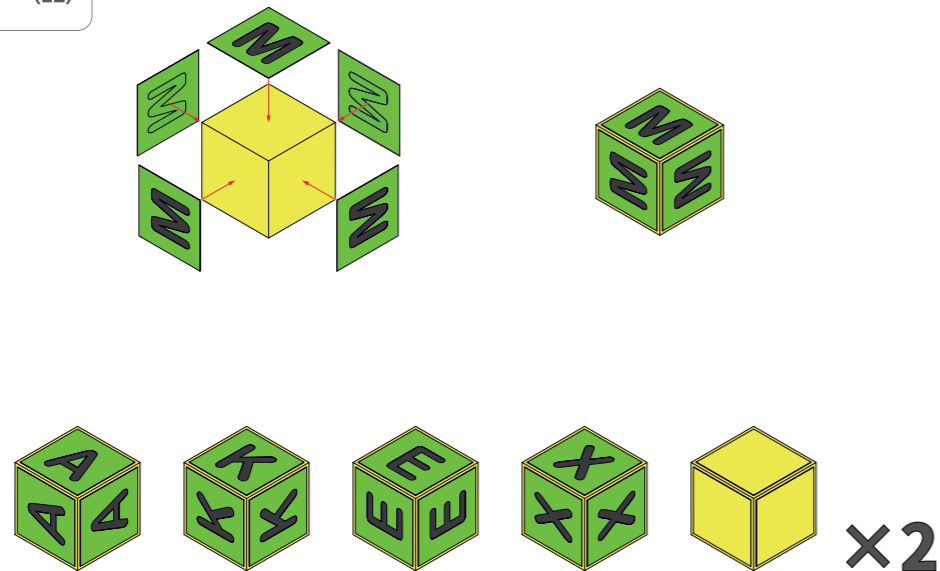

## Mid-Court Assembly 中场护栏组装

15

-  Octagonal Pillar 960 with Cover  
带底端封盖八棱柱960 (1)
-  Octagonal Pillar 500 with Cover  
带底端封盖八棱柱500 (2)
-  Flat Beam 120 with Lock  
带三卡锁扁铝120 (6)

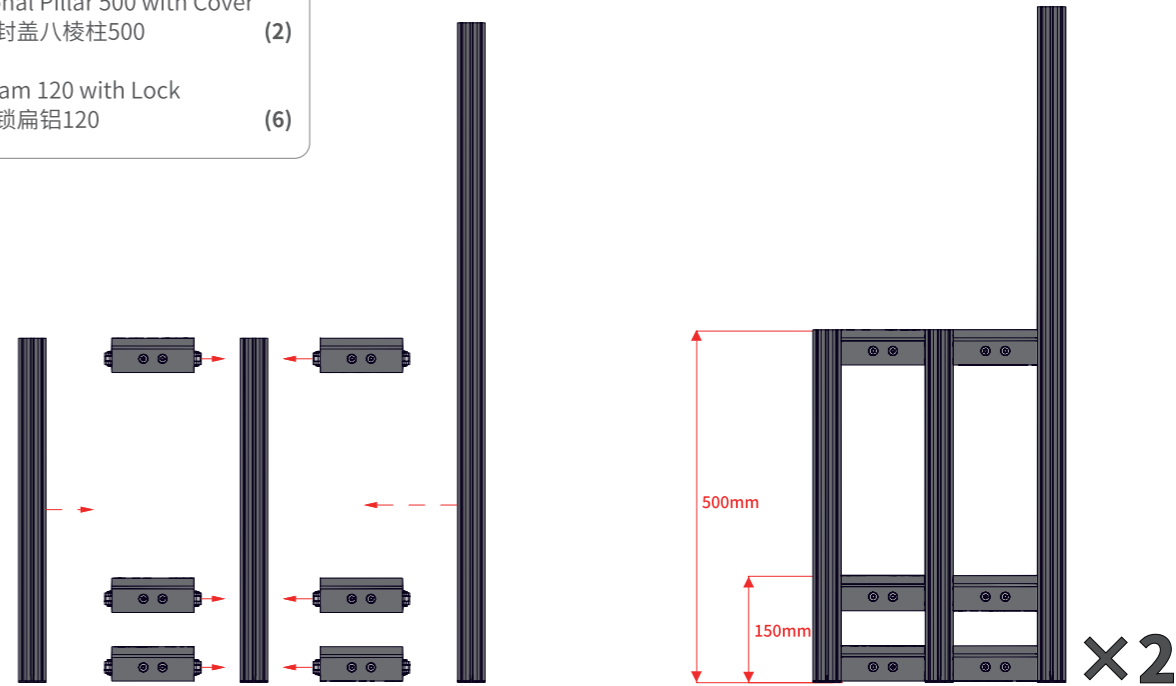

## Mid-Court Assembly 中场护栏组装

16



Flat Beam 92 with Sticker  
带贴纸扁铝92 (10)

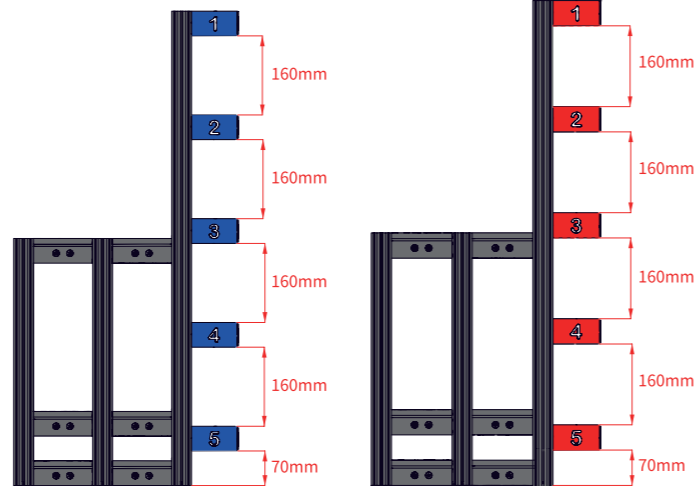
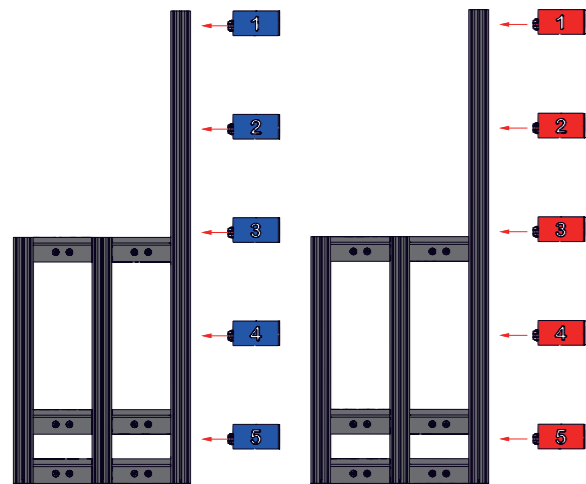

## Mid-Court Assembly 中场护栏组装

17



Flat Beam 960 with Lock  
带三卡锁扁铝960 (6)



PVC Board Mix  
红黑蓝黑护栏板 (1)



PVC Board C4  
PVC板C4 (2)

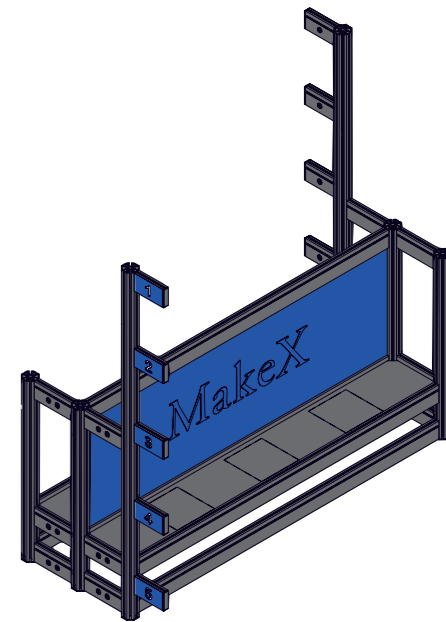
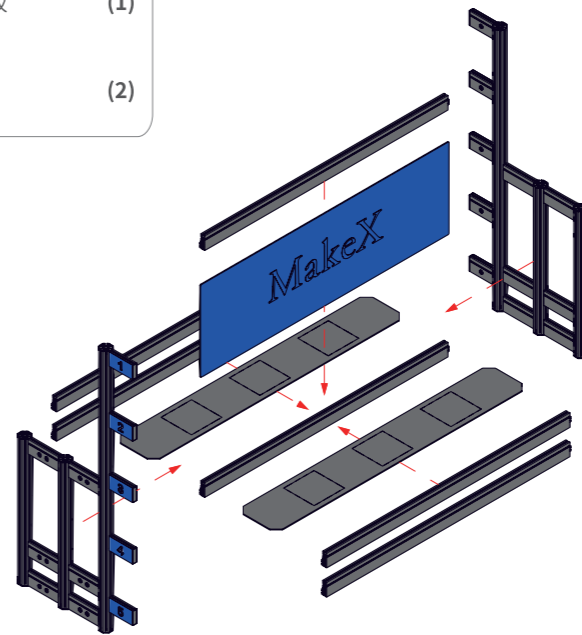

## Mid-Court Assembly 中场护栏组装

18

-  Flat Beam 960 with Lock  
带三卡锁扁铝960 (8)
-  Octagonal Pillar 500 with Cover  
带底端封盖八棱柱500 (2)

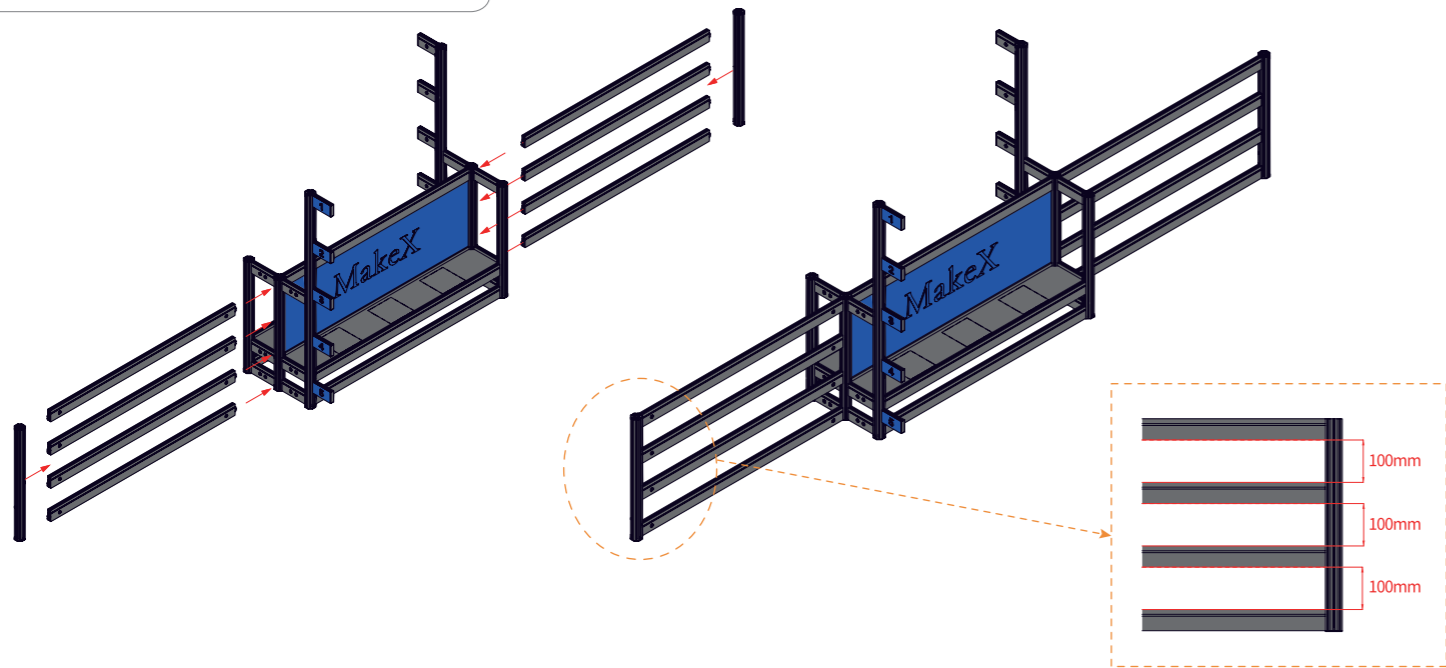

## Mid-Court Assembly 中场护栏组装

19

-  Octagonal Pillar Cover  
八棱柱封盖 (8)

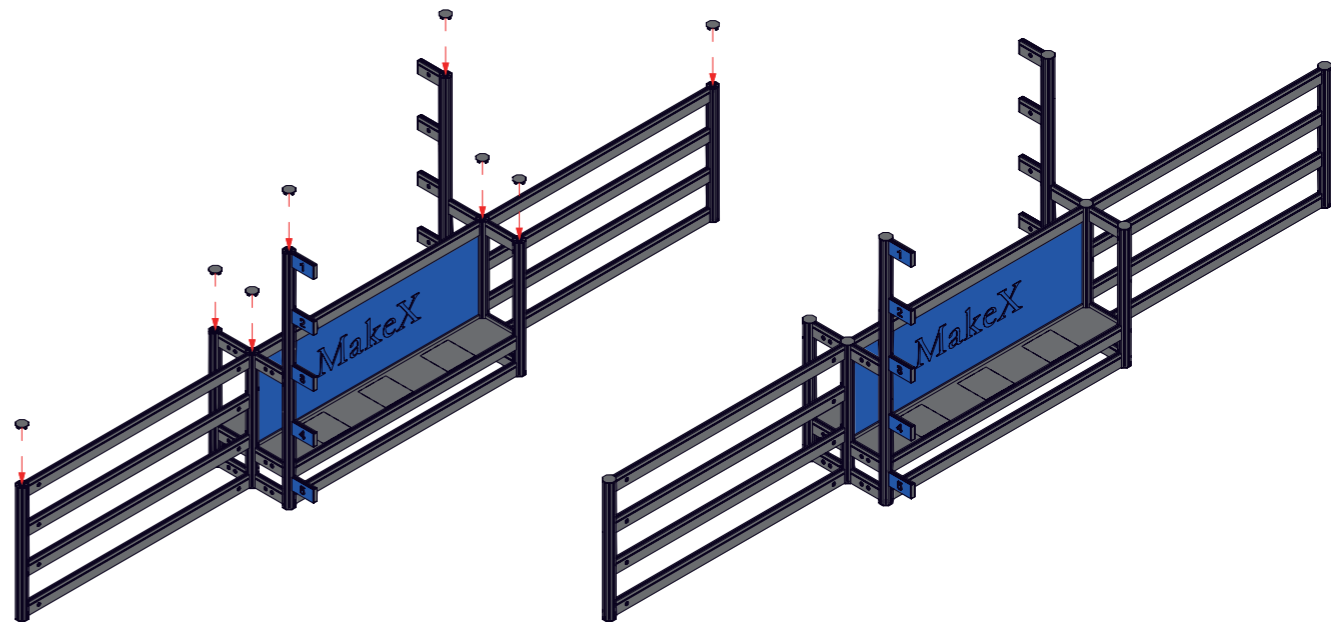

## Half-Court Assembly 蓝方半场安装

Same installation method of the Red Half-Court  
(红方半场安装方法相同)

20

### Bottom Fence Assembly/安装底面围栏



Flat Beam 160 with Lock  
带三卡锁扁铝160 (2)



Octagonal Pillar 960 with Cover  
带底端封盖八棱柱960 (2)

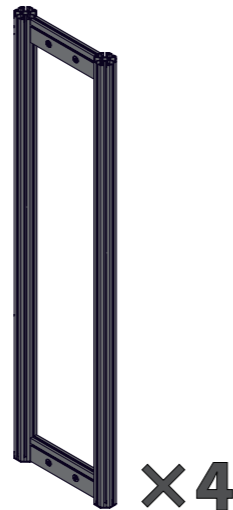
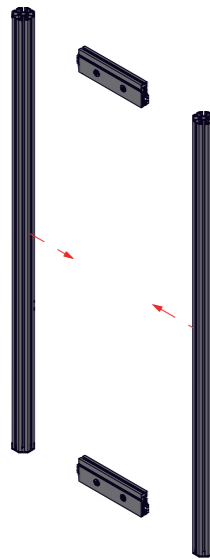

## Half-Court Assembly 蓝方半场安装

Same installation method of the Red Half-Court  
(红方半场安装方法相同)

21

### Bottom Fence Assembly/安装底面围栏



Flat Beam 293 with Lock  
带三卡锁扁铝293 (3)



Flat Beam 960 with Lock  
带三卡锁扁铝960 (5)



Octagonal Pillar 960 with Cover  
带底端封盖八棱柱960 (2)

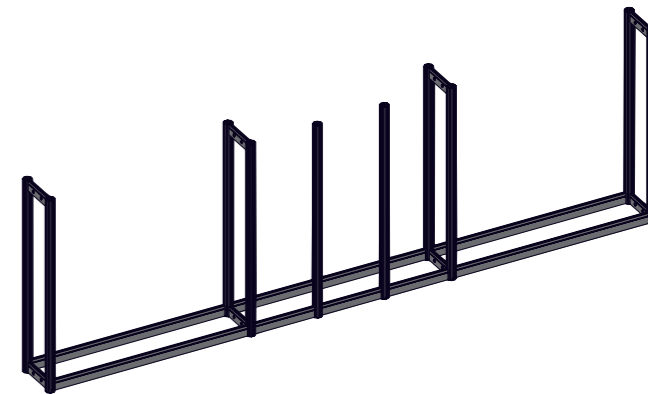
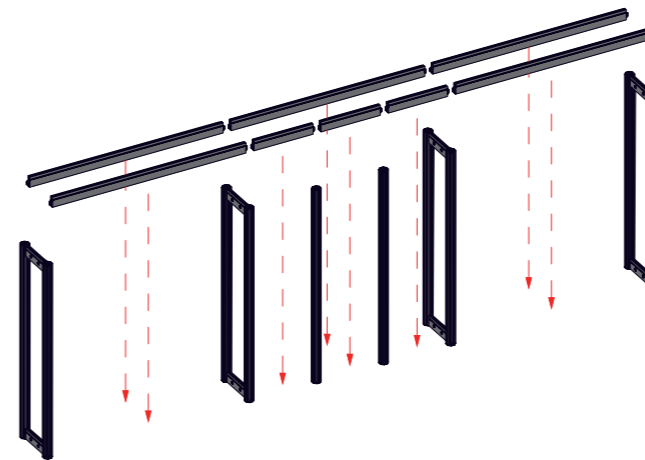

# Half-Court Assembly 蓝方半场安装

Same installation method of the Red Half-Court  
(红方半场安装方法相同)

22

## Bottom Fence Assembly/安装底面围栏

-  Flat Beam 293 with Lock  
带三卡锁扁铝293 (2)
-  Flat Beam 960 with Lock  
带三卡锁扁铝960 (2)
-  MakeX Board Blue&Black  
蓝黑护栏板 (2)
-  Board C2 Blue&Black  
蓝黑板C2 (2)
-  Board C3 Blue&Black  
蓝黑板C3 (1)

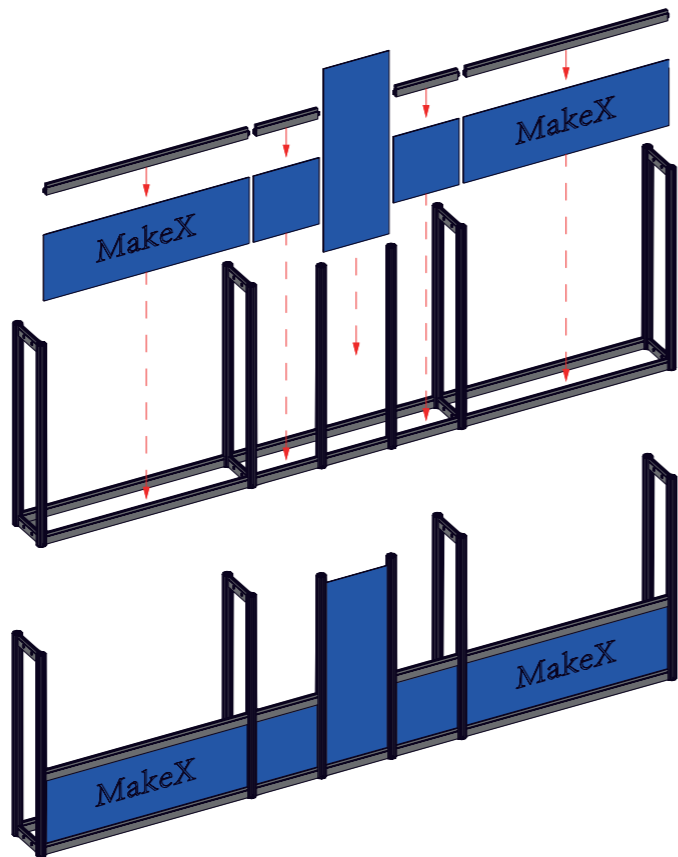

# Half-Court Assembly 蓝方半场安装

Same installation method of the Red Half-Court  
(红方半场安装方法相同)

23

## Bottom Fence Assembly 安装底面围栏

-  Metal Net  
铁网 (2)
-  Board C1 Blue&Black  
蓝黑板C1 (2)

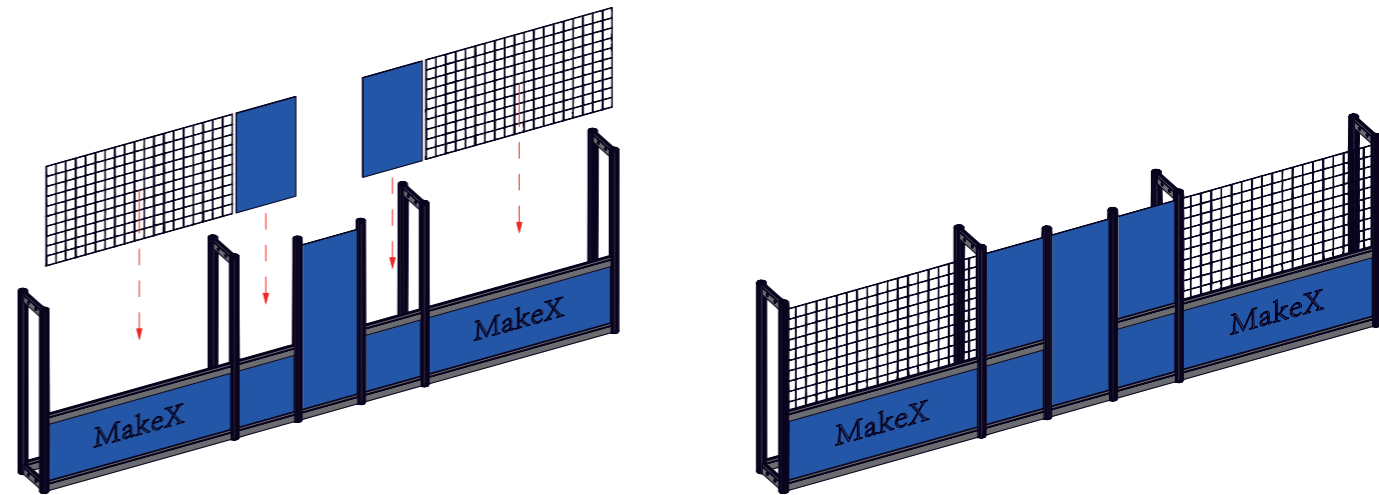

## Half-Court Assembly 蓝方半场安装

Same installation method of the Red Half-Court  
(红方半场安装方法相同)

24

### Bottom Fence Assembly/安装底面围栏

 Flat Beam 293 with Lock  
带三卡锁扁铝293 (3)

 Flat Beam 960 with Lock  
带三卡锁扁铝960 (4)

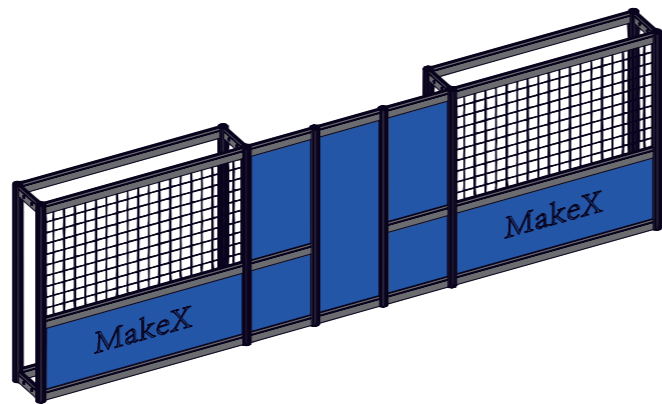
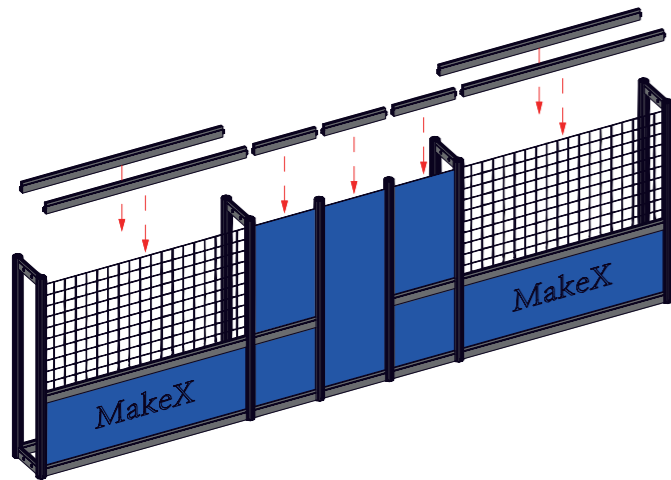

## Half-Court Assembly 蓝方半场安装

Same installation method of the Red Half-Court  
(红方半场安装方法相同)

25

### Bottom Fence Assembly/安装底面围栏

 Octagonal Pillar Connector  
八棱柱接驳条 (2)

 Octagonal Pillar 600  
八棱柱600 (2)

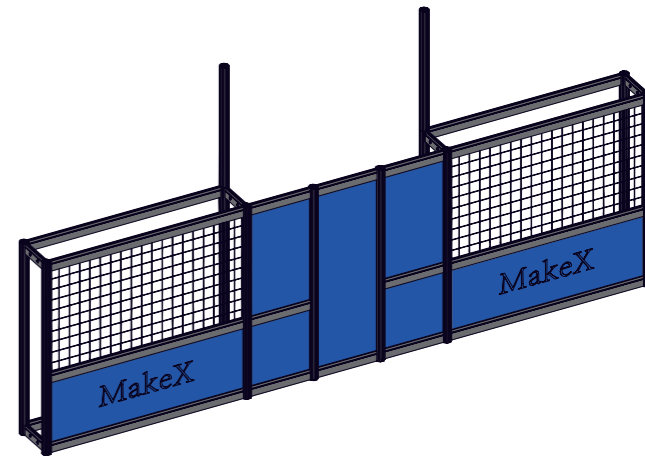
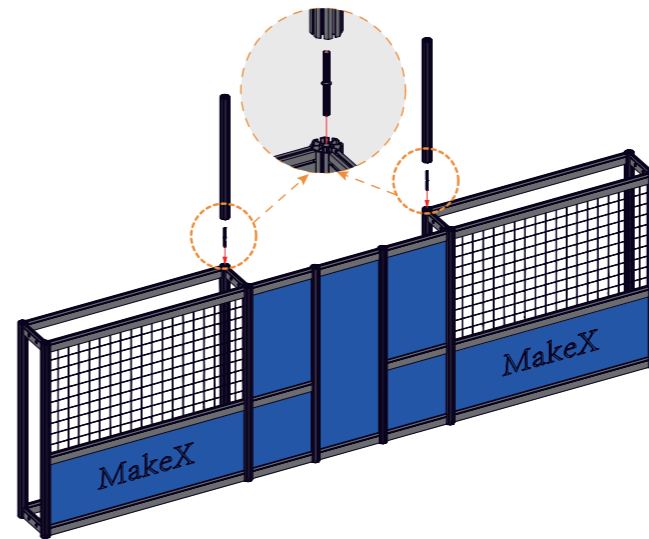

# Half-Court Assembly 蓝方半场安装

Same installation method of the Red Half-Court  
(红方半场安装方法相同)

26

## Bottom Fence Assembly/安装底面围栏

-  Flat Beam 960 with Lock  
带三卡锁扁铝960 (2)
-  Metal Net  
铁网 (1)
-  Flat Beam 45° with Lock  
带斜卡锁扁铝 (4)

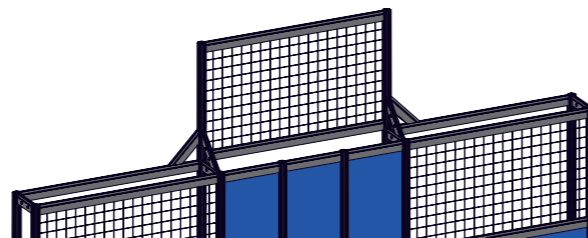
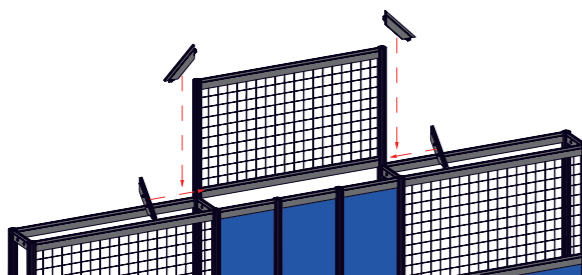
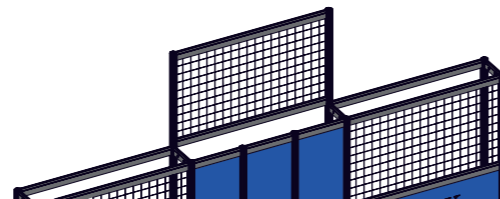
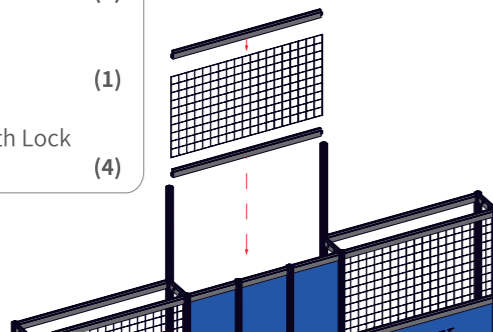

# Half-Court Assembly 蓝方半场安装

Same installation method of the Red Half-Court  
(红方半场安装方法相同)

27

## Bottom Fence Assembly/安装底面围栏

-  Flat Beam 92  
扁铝92 (4)
-  Flat Beam 104  
扁铝104 (2)
-  Board 1  
木板1 (2)
-  Board 2  
木板2 (2)
-  Acrylic Board C4  
亚克力板C4 (2)

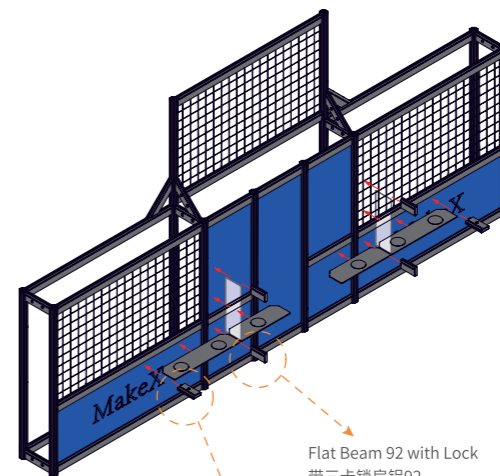

Flat Beam 92 with Lock  
带三卡锁扁铝92

Flat Beam 104 with Lock  
带三卡锁扁铝104

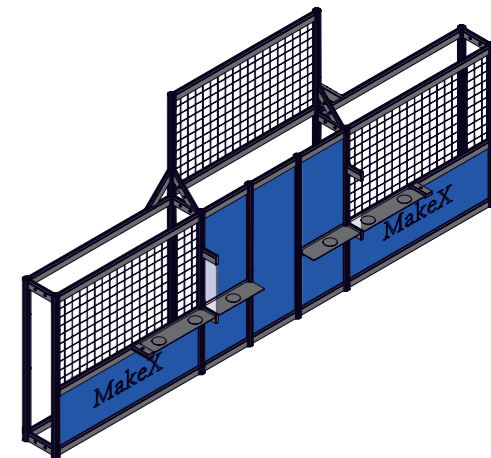

## Half-Court Assembly 蓝方半场安装

Same installation method of the Red Half-Court  
(红方半场安装方法相同)

28

### Bottom Fence Assembly/安装底面围栏

-  Flat Beam 220 with Lock  
带三卡锁扁铝220 (6)
-  Octagonal Pillar 600 with Cover  
带底端封盖八棱柱600 (2)
-  Acrylic Board C1  
亚克力板C1 (2)
-  Acrylic Board C2  
亚克力板C2 (2)

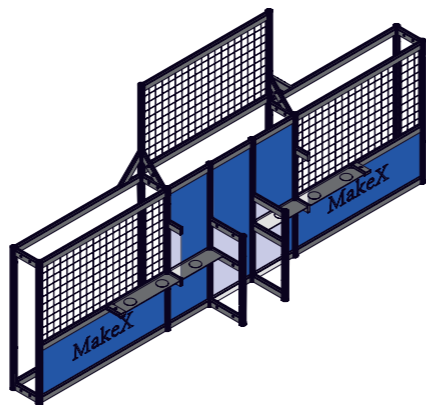
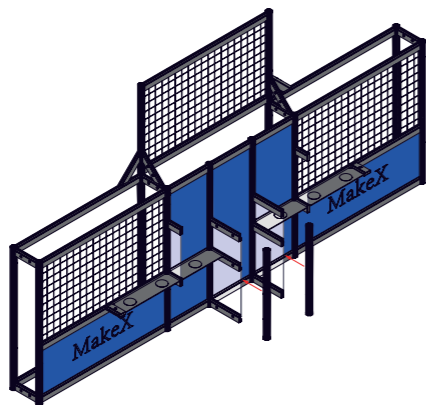
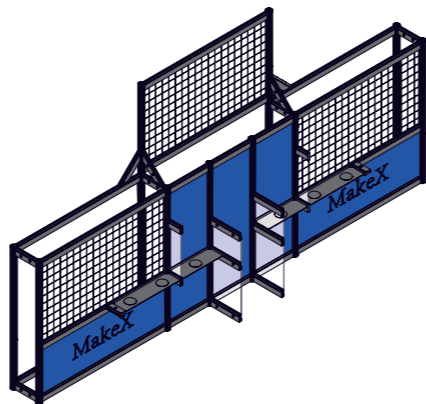
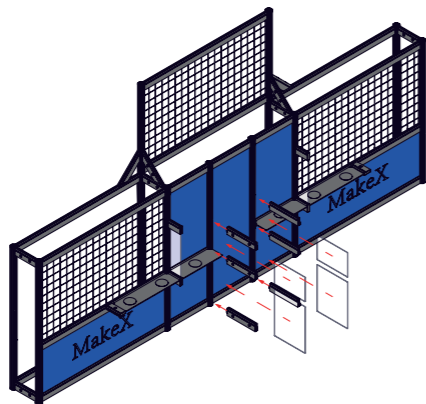

## Half-Court Assembly 蓝方半场安装

(红方半场安装方法相同)  
Same installation method of the Red Half-Court

29

### Bottom Fence Assembly/安装底面围栏

-  Flat Beam 293 with Lock  
带三卡锁扁铝293 (1)
-  Acrylic Board C3  
亚克力板C3 (1)
-  Octagonal Pillar Cover  
八棱柱封盖 (12)

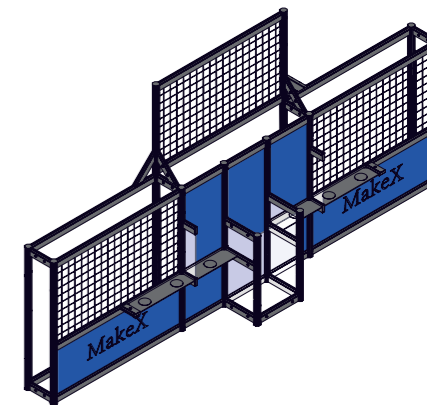
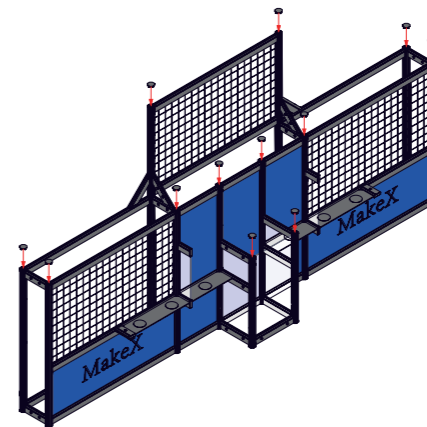
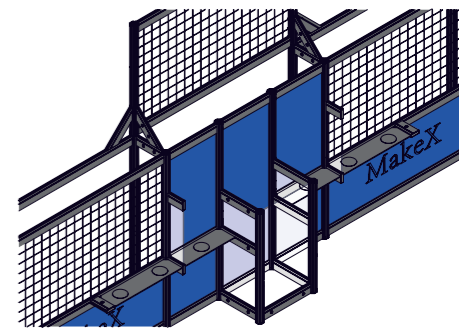
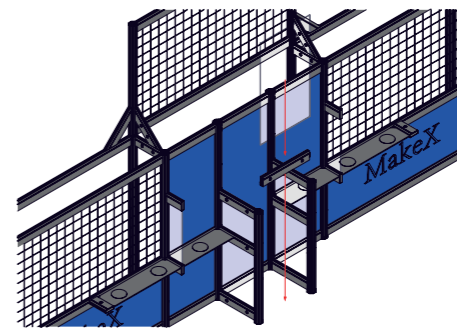



## Half-Court Assembly 蓝方半场安装

Same installation method of the Red Half-Court  
(红方半场安装方法相同)

30

### Side Fence Assembly/安装侧面围栏

-  Flat Beam 960 with Lock  
带三卡锁扁铝960 (2)
-  Octagonal Pillar 400 with Cover  
带底端封盖八棱柱400 (1)
-  **MakeX** PVC Board Blue&Black  
蓝黑护栏板 (2)

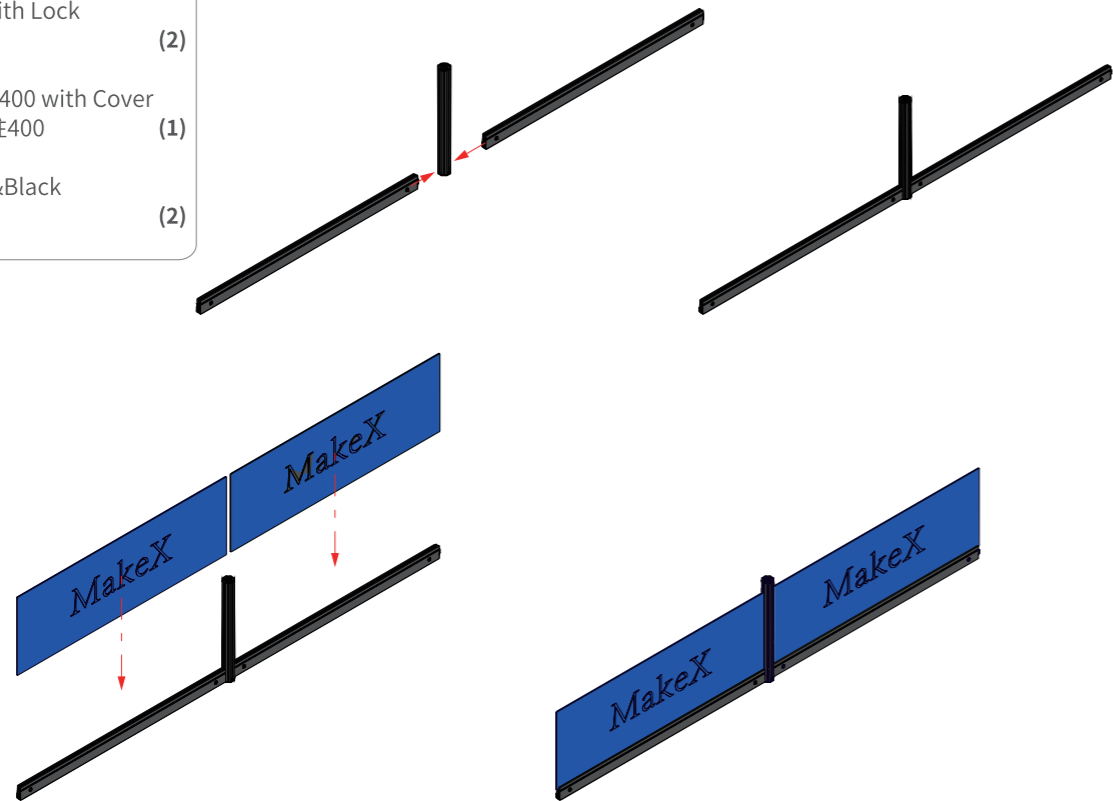

## Half-Court Assembly 蓝方半场安装

Same installation method of the Red Half-Court  
(红方半场安装方法相同)

31



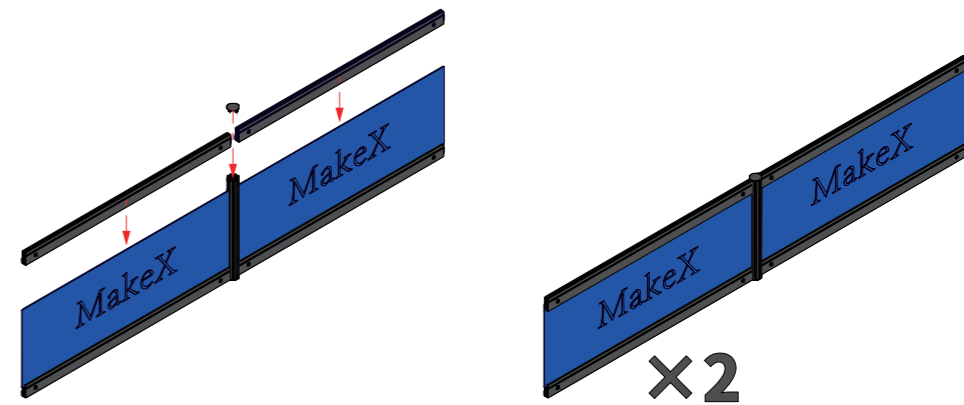

### Side Fence Assembly/安装侧面围栏

-  Octagonal Pillar Cover  
八棱柱封盖 (1)
-  Flat Beam 960 with Lock  
带三卡锁扁铝960 (2)



## Arena Assembly全场组装

32

-  Blue Side Fence  
蓝方侧面围栏 (2)
-  Red Side Fence  
红方侧面围栏 (2)
-  Mid-Court  
中场护栏 (1)
-  Blue Bottom Fence  
蓝方底面围栏 (1)
-  Red Bottom Fence  
红方底面围栏 (1)

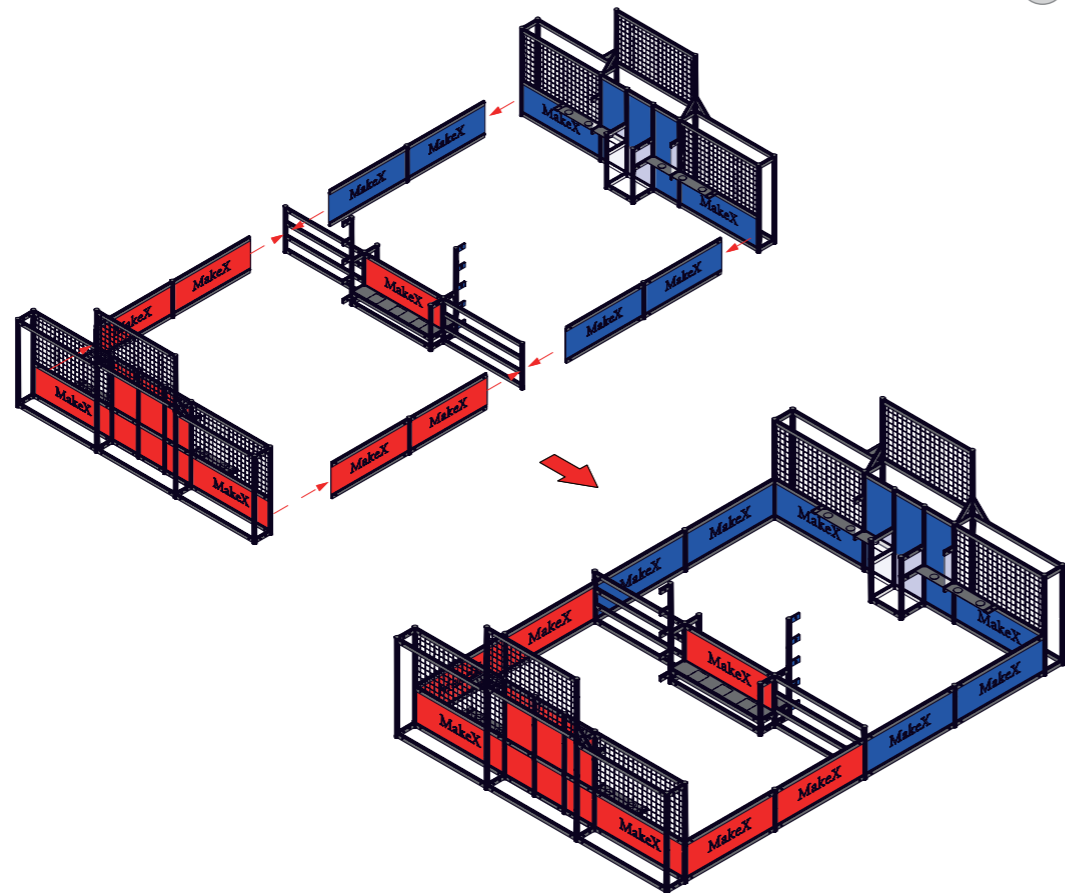

## Arena Assembly全场组装

33

-  Mat  
地图 (1)

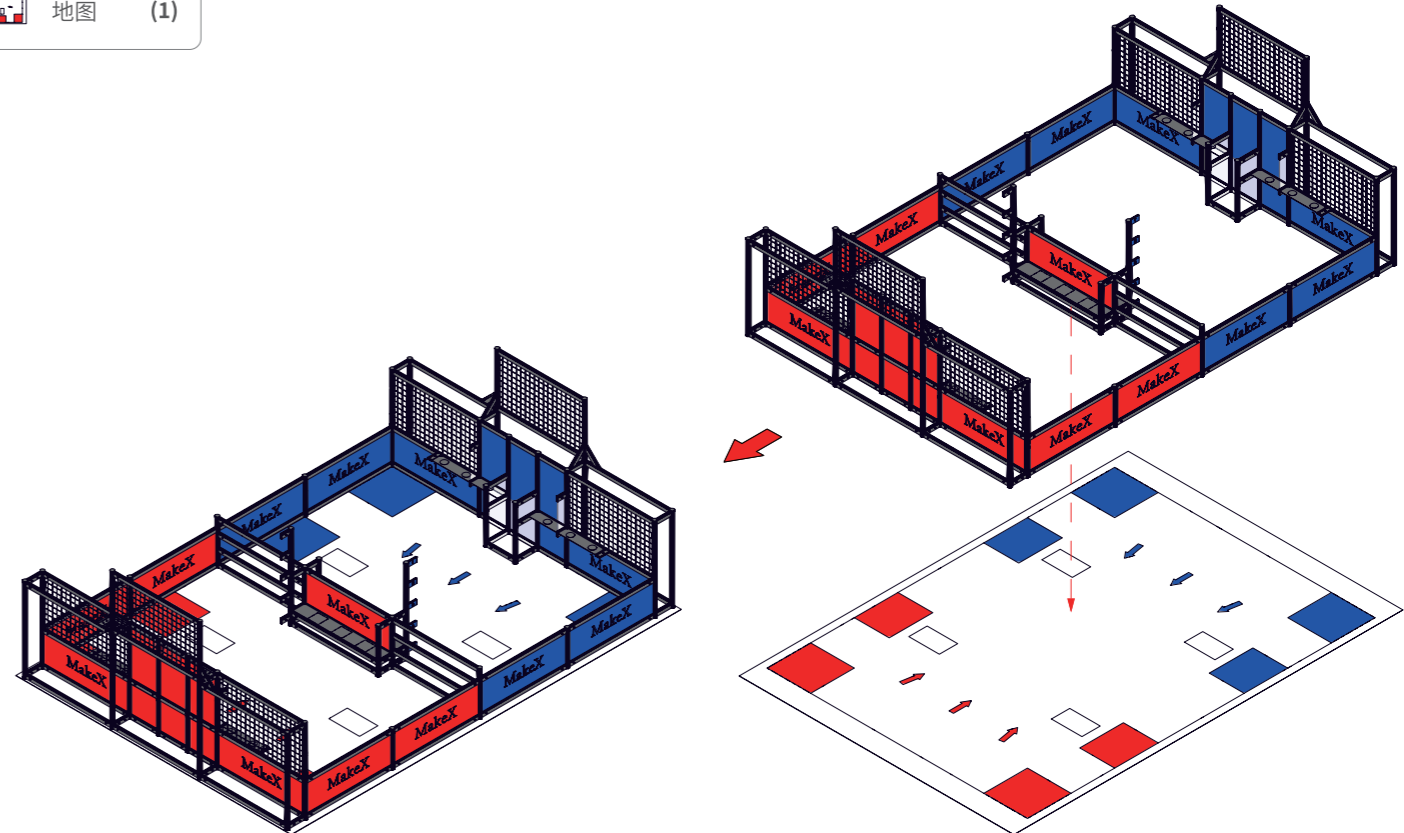

## Props Placement场地道具摆放

34



Bottle Red&Black  
红黑保龄球瓶 (6)



Bottle Blue&Black  
蓝黑保龄球瓶 (6)

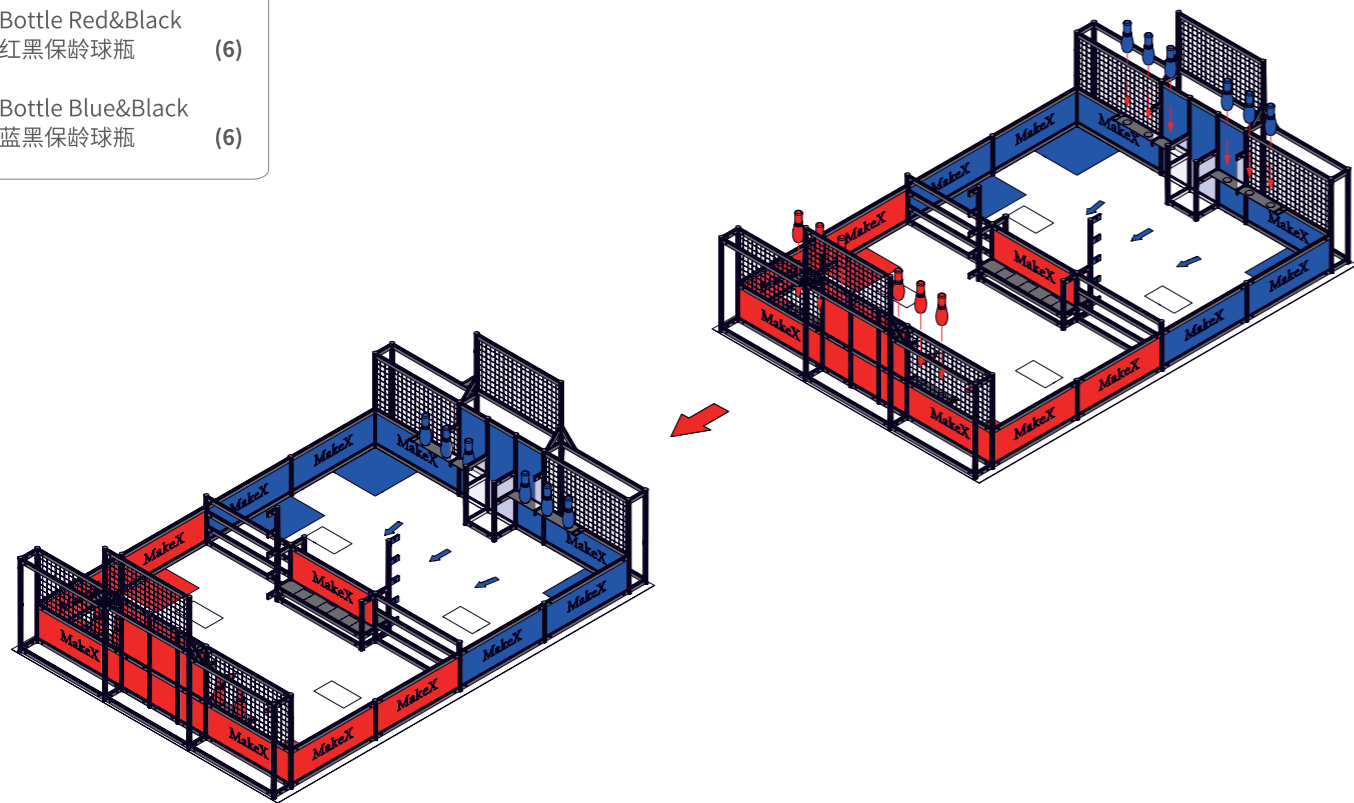

## Props Placement场地道具摆放

35



Small Cube  
黄色方块 (80)

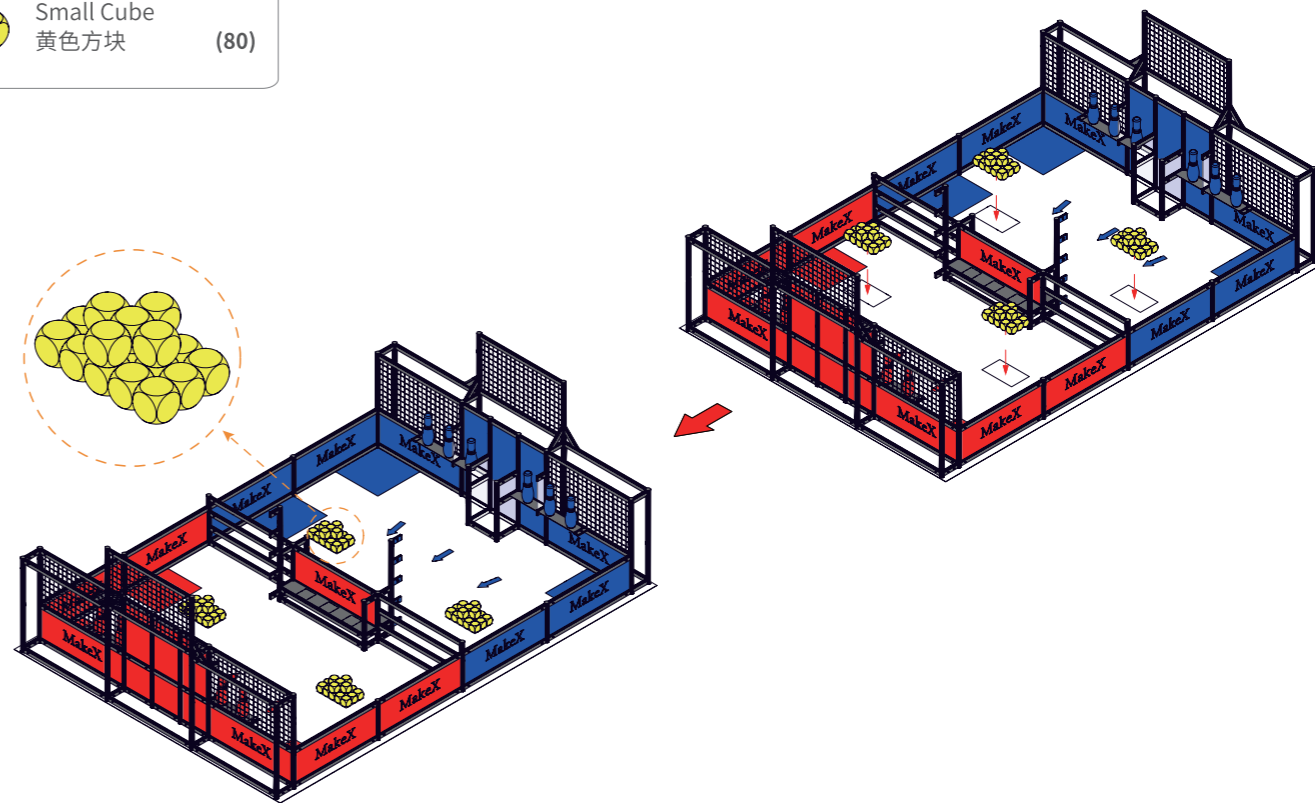

## Props Placement场地道具摆放

36



Cube with Sticker  
带贴纸方块

(12)

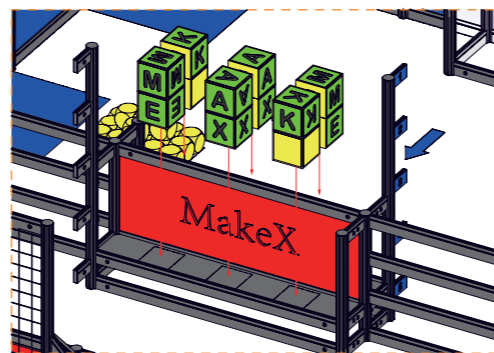
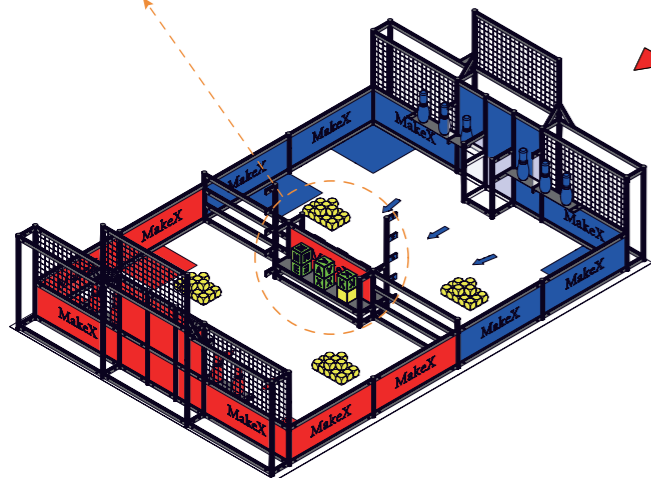
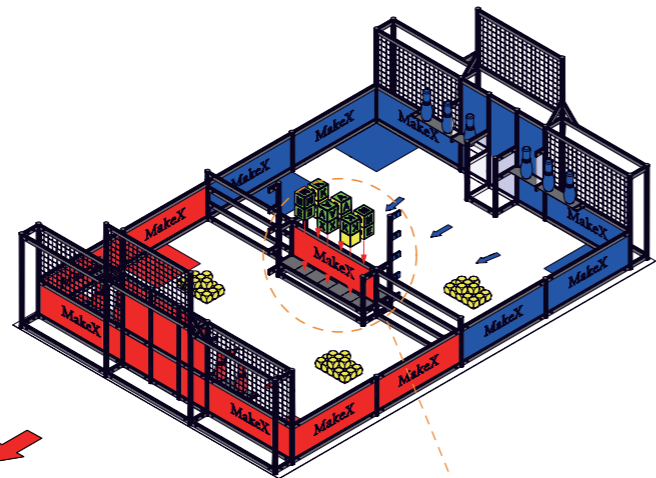
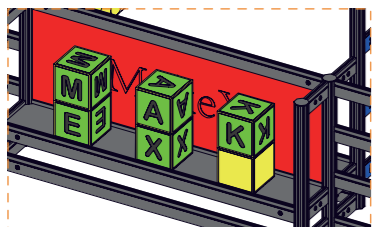

## Arena完整场地示意图

37

