

2020

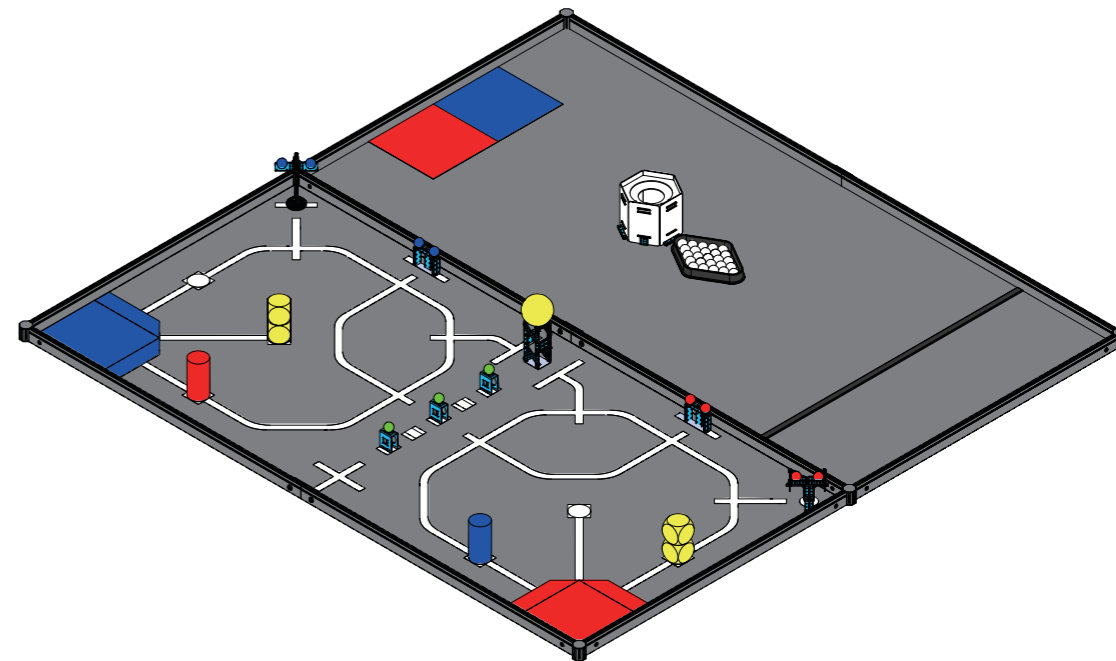









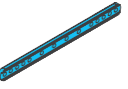

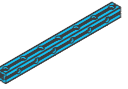
MAKE

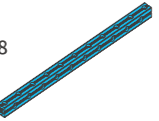
STARTER Smart Links Arena Assembly Instructions 智慧交通场地搭建步骤图

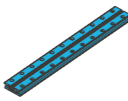
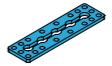
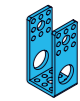
MAKE

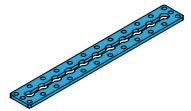

Parts List 零件清单

Parts and Quantities\零件及数量	Index\编号	Parts and Quantities\零件及数量	Index\编号	Parts and Quantities\零件及数量	Index\编号
6x Slide Beam0824-048 滑轨双孔梁0824-048 	①	4x Beam0412-156 单孔梁0412-156 	⑦	13x Bracket 3*3 支架3*3 	⑬
9x Slide Beam0824-064 滑轨双孔梁0824-064 	②	2x Square Beam0808-104 单孔方形梁104 	⑧	4x Bracket 3*6 支架3*6 	⑭
2x Slide Beam0824-128 滑轨双孔梁0824-128 	③	2x Square Beam0808-168 单孔方形梁168 	⑨	2x Bracket U1 支架U1 	⑮
2x Slide Beam0824-176 滑轨双孔梁0824-176 	④	4x Plate0324-088 连接片0324-088 	⑩	2x Bracket U-C U型支架C 	⑯
12x Beam0412-076 单孔梁0412-076 	⑤	2x Plate0324-184 连接片0324-184 	⑪	8x 42BYG Stepper Motor Bracket 42步进电机支架 	⑰
4x Beam0412-092 单孔梁0412-092 	⑥	2x Plate 45° 45°连接片 	⑫	4x Cuttable Linkage 连杆 	⑱

Parts and Quantities\零件及数量	Index\编号	Parts and Quantities\零件及数量	Index\编号	Parts and Quantities\零件及数量	Index\编号
2x Timing Pulley 62T 62T同步带轮 	⑱	20x Shaft Collar 4mm 4mm轴套 	⑳	2x M4*16mm Screw M4*16半圆头内六角螺丝 	㉑
2x Timing Pulley 90T 90T同步带轮 	㉒	2x D Shaft 4*56mm D型轴4*56mm 	㉓	10x M4*14mm Screw M4*14半圆头内六角螺丝 	㉔
3x 36mm DC Motor Bracket 36编码电机支架 	㉕	4x D Shaft 4*128 D型轴4*128mm 	㉖	16x M4*22mm Screw M4*22半圆头内六角螺丝 	㉗
4x Shaft Connector 4mm 传动固定盘 	㉘	24x Plastic Rivet R4100(White) R4100铆钉(白尼龙) 	㉙	22x Screw Headless M3*5 M3*5无头内六角螺钉 	㉚
4x Flange Bearing 4*8*3 4*8*3法兰轴承 	㉛	44x Plastic Rivet R4060(Black) R4060铆钉(黑尼龙) 	㉜	16x M4 Nut M4螺母 	㉝
2x Shaft 4*88 D4*88光轴 	㉞	56x M4*8mm Screw M4x8半圆头内六角螺丝 	㉟	16x Lock Nut M4 M4防松螺母 	㊱

Parts and Quantities\零件及数量	Index\编号	Parts and Quantities\零件及数量	Index\编号	Parts and Quantities\零件及数量	Index\编号
8x Yellow Block 黄色方块 	㊲	2x Red Obstacle 红色障碍物 	㊳	36x Rubber Band 橡皮筋 	㊴
4x Red EVA Ball 红色EVA球 	㊵	2x Blue Obstacle 蓝色障碍物 	㊶	1x Double-Sided Tape 双面胶 	㊷
4x Blue EVA Ball 蓝色EVA球 	㊸	1x Wrench 5mm&7mm 双头扳手 	㊹	1x Mat 地图 	㊺
3x Green EVA Ball 绿色EVA球 	㊻	2x HEX Allen Key 1.5mm 1.5mm L形六角扳手 	㊼	6x Side Acrylic 侧板亚克力 	㊽
25x White EVA Ball 白色EVA球 	㊾	1x Screwdriver 螺丝刀 	㊿	1x Bottom Acrylic 底板亚克力 	①
1x Yellow PU Ball 黄色PU球 	②	1x Ball Holder 摆球架 	③	1x Top Acrylic Φ80mm 顶板亚克力Φ80mm 	④

Parts and Quantities\零件及数量	Index\编号	Parts and Quantities\零件及数量	Index\编号
1× 顶板亚克力 Φ130mm Top Acrylic Φ130mm	55	1× 魔术贴(毛面) Hook-and-Loop (Loop)	56

M01

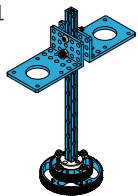

M02

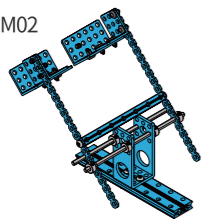

M03

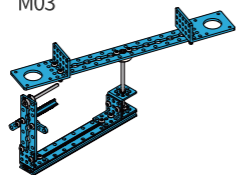

M04

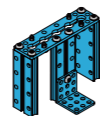

M06/M07



M08





M09



M10





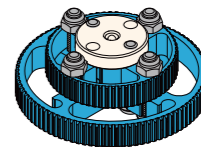
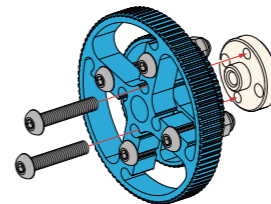
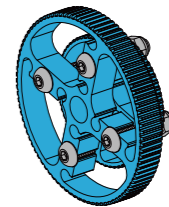
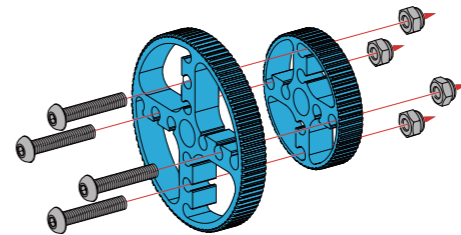

M01 Assembly Instructions 搭建步骤

- 1×  19
- 1×  20
- 1×  22
- 6×  33
- 4×  36





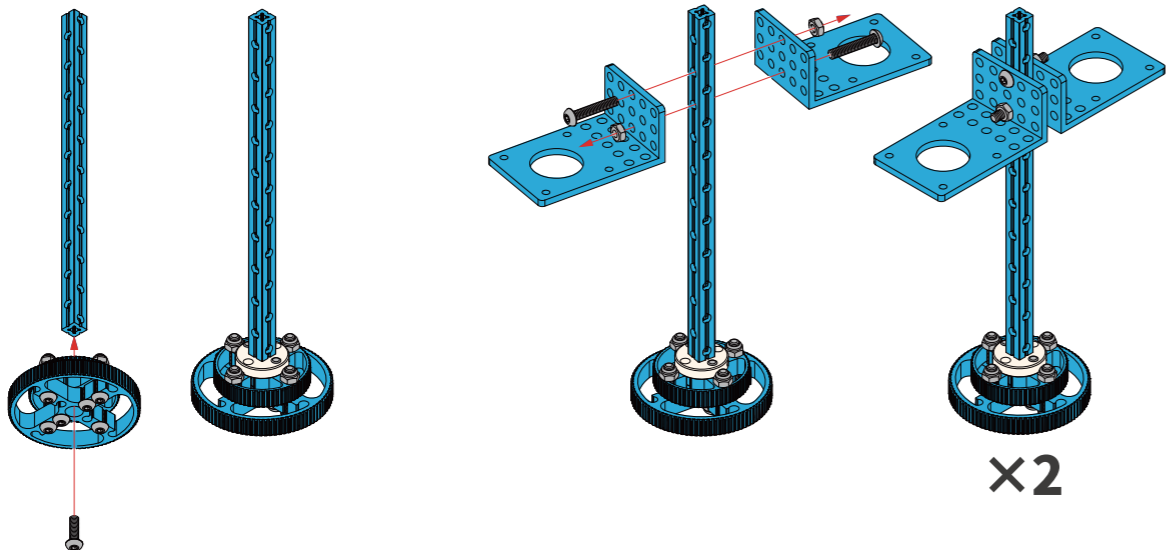

M01 Assembly Instructions 搭建步骤

- 2x  (17)
- 1x  (9)
- 2x  (35)
- 1x  (32)
- 2x  (33)





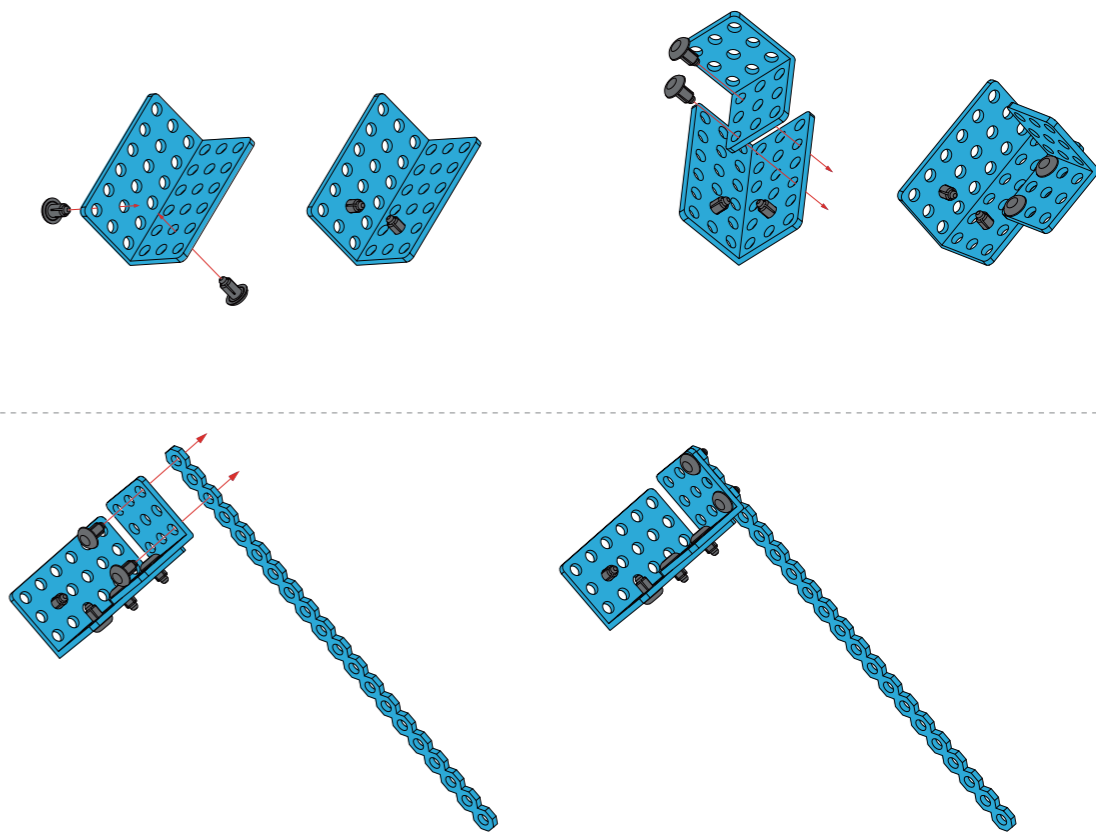

M02 Assembly Instructions 搭建步骤

- 1x  (14)
- 6x  (29)
- 1x  (13)
- 1x  (18)



M02 Assembly Instructions 搭建步骤

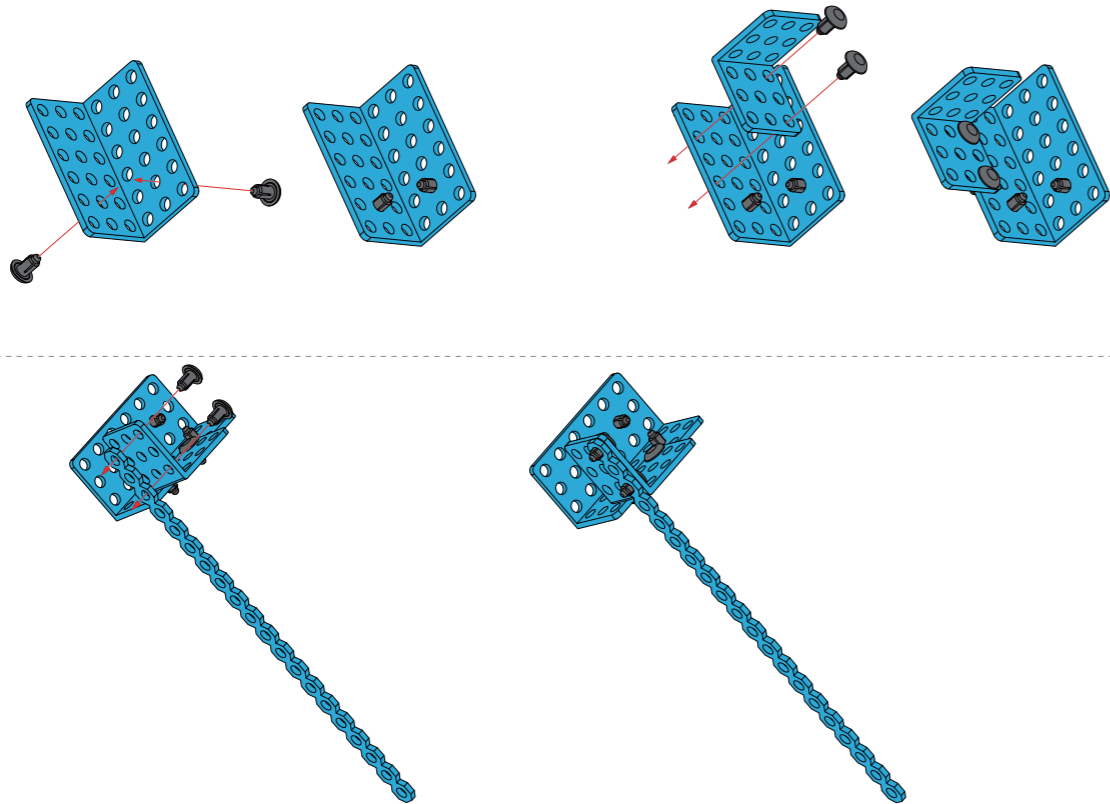

08

- 1x  (14)
- 6x  (29)
- 1x  (13)
- 1x  (18)





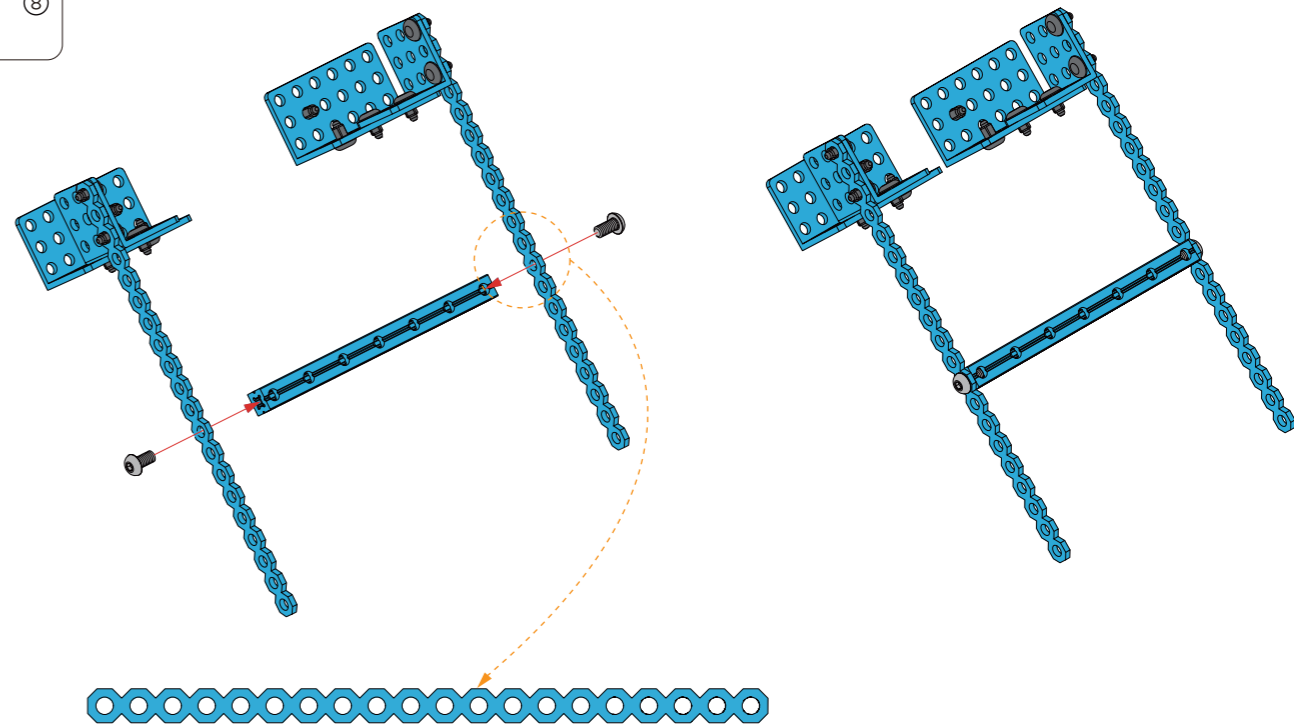

M02 Assembly Instructions 搭建步骤

09

- 2x  (30)
- 1x  (8)



M02 Assembly Instructions 搭建步骤

- 2x  ③⑩
- 1x  ③
- 1x  ⑩①⑥
- 2x  ②⑦
- 6x  ②⑤

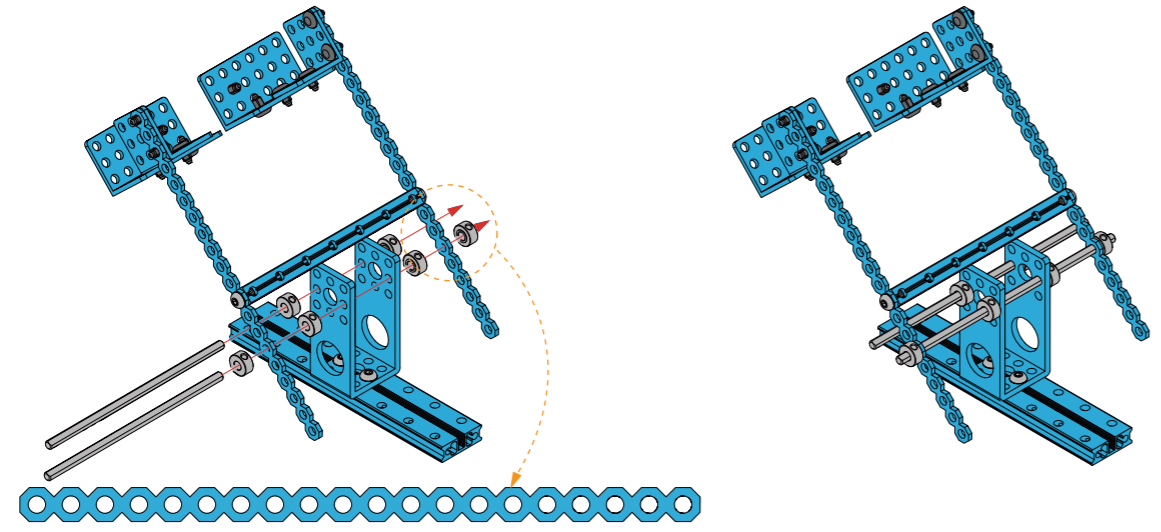
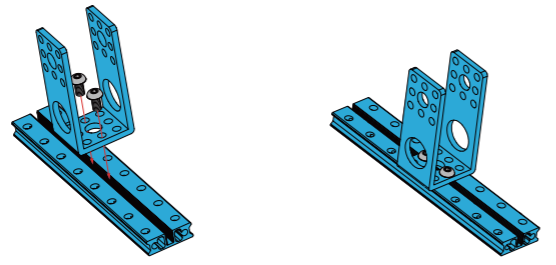

M02 Assembly Instructions 搭建步骤



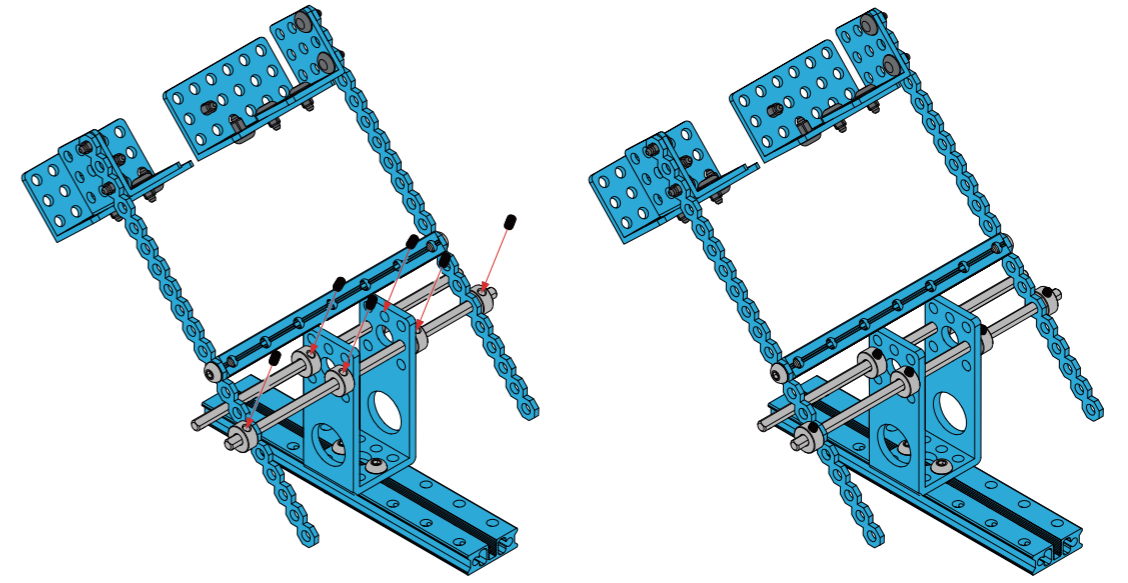

- 6x  ③④







x2

M03 Assembly Instructions 搭建步骤

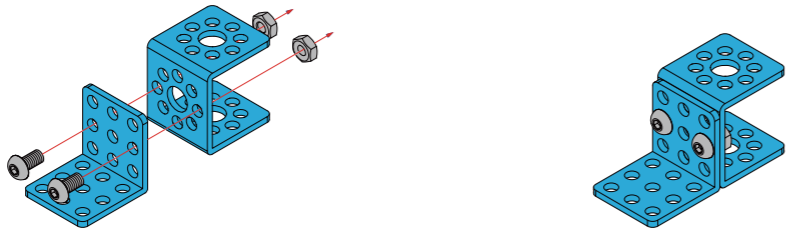
12

- 1x  (15)
- 1x  (13)
- 2x  (35)
- 2x  (30)



- 1x  (11)
- 2x  (17)
- 4x  (36)
- 4x  (32)

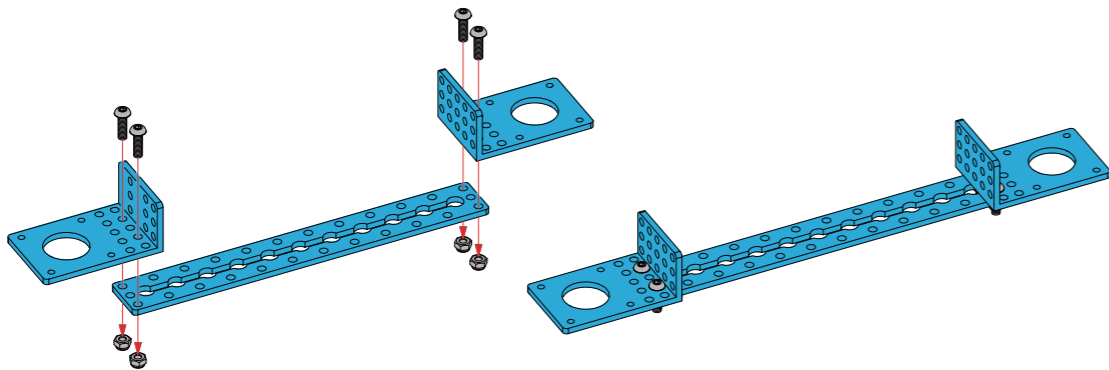

M03 Assembly Instructions 搭建步骤



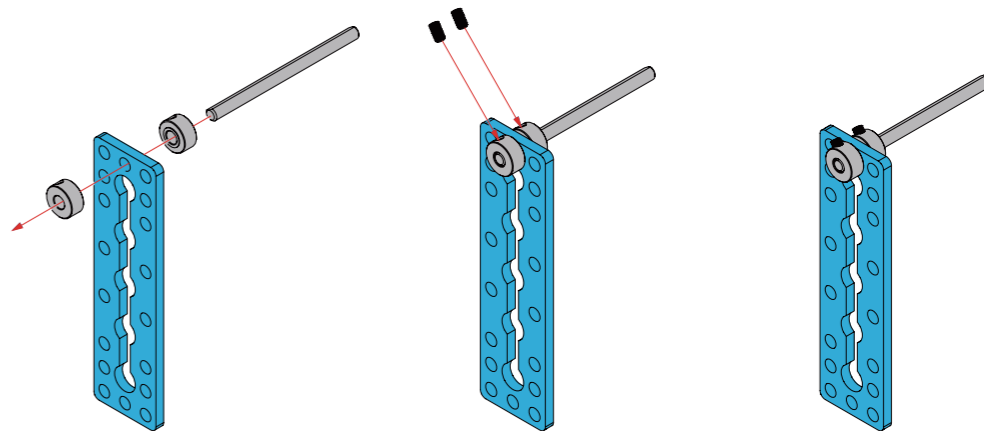

13

- 1x  (26)
- 1x  (10)
- 2x  (25)
- 2x  (34)



M03 Assembly Instructions 搭建步骤





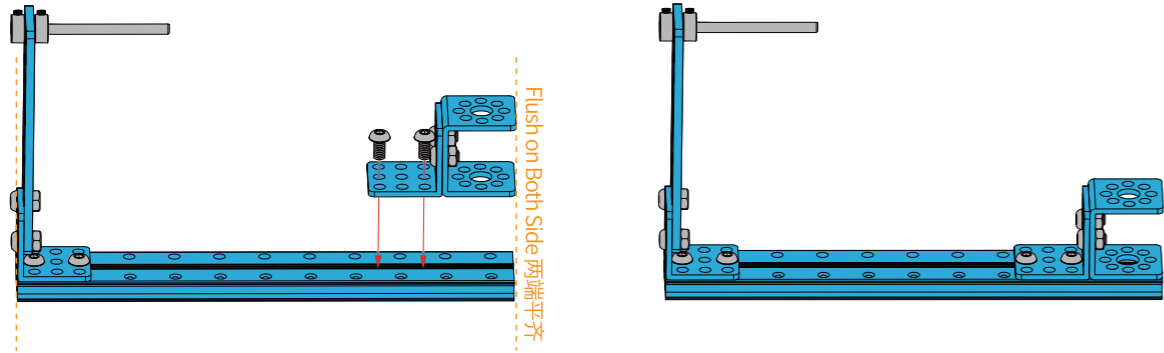
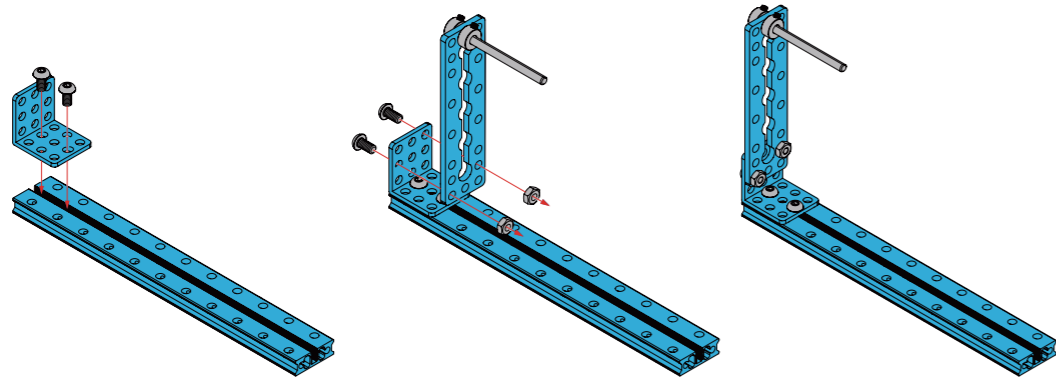

14

- 1x  (4)
- 1x  (13)
- 2x  (35)
- 6x  (30)



M03 Assembly Instructions 搭建步骤



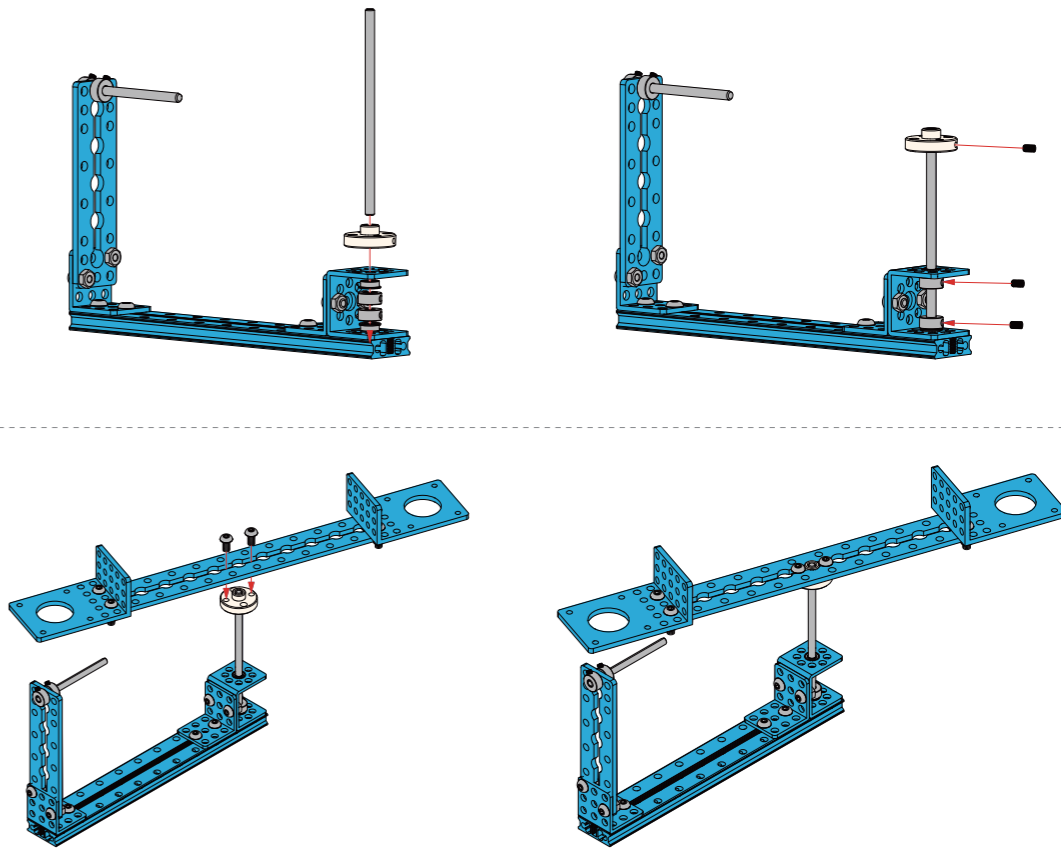

15

- 1x  (24)
- 1x  (22)
- 2x  (25)
- 2x  (23)
- 3x  (34)
- 2x  (30)





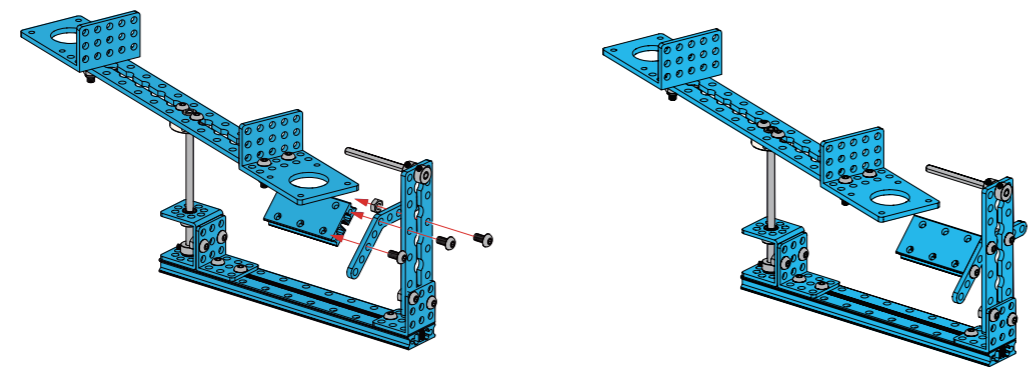

M03 Assembly Instructions 搭建步骤

M03 蓝/Blue

- 1x  ①
- 1x  ⑫
- 1x  ③⑤
- 3x  ③①





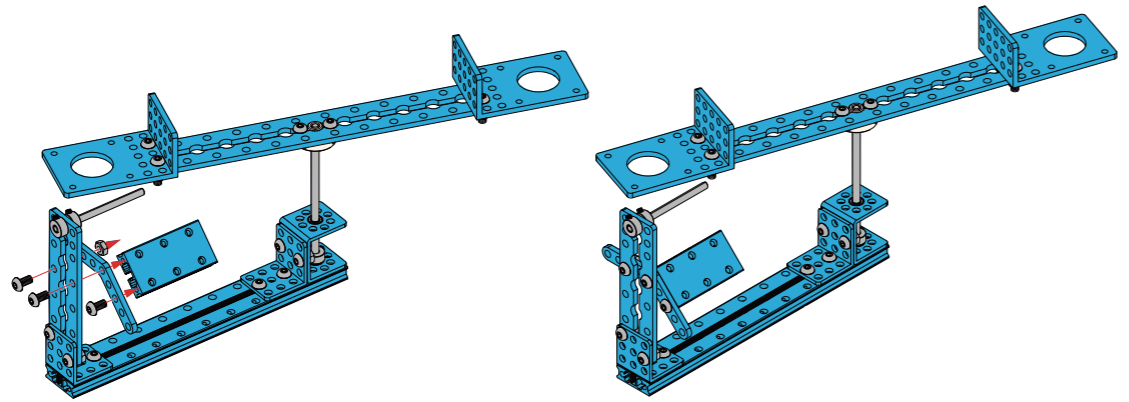

M03 红/Red

- 1x  ①
- 1x  ⑫
- 1x  ③⑤
- 3x  ③①



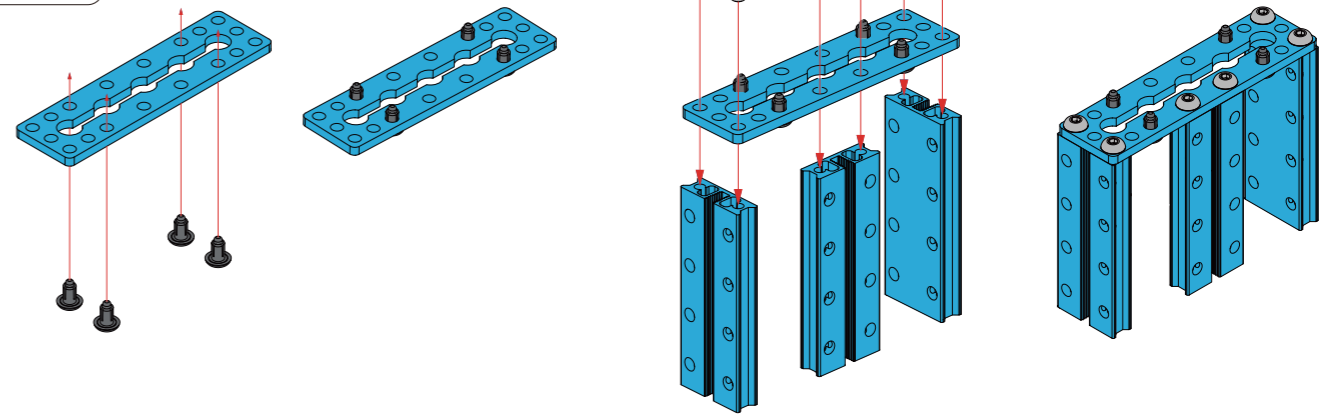

M04 Assembly Instructions 搭建步骤

- 3x  ②
- 1x  ⑩
- 6x  ③①
- 4x  ②⑨



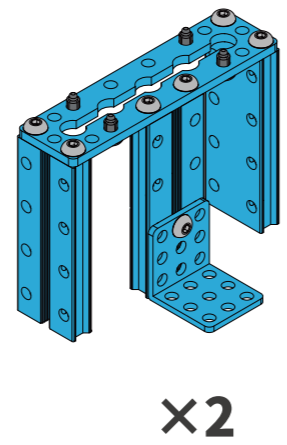
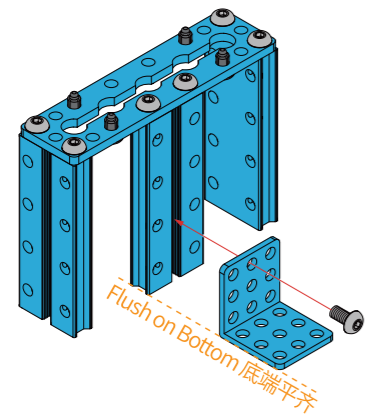

M04 Assembly Instructions 搭建步骤

- 1x  ⑬
- 1x  ⑳





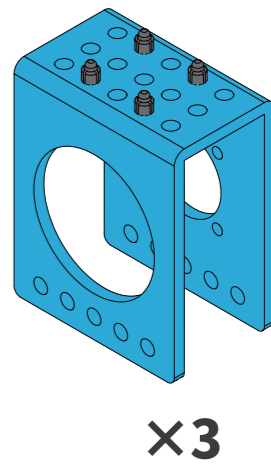
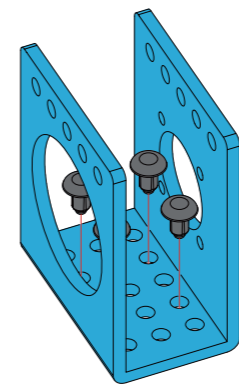

M06/M07 Assembly Instructions 搭建步骤

- 1x  ㉑
- 4x  ㉒



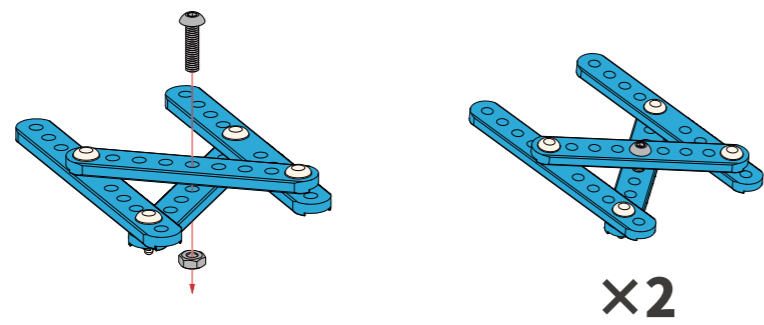
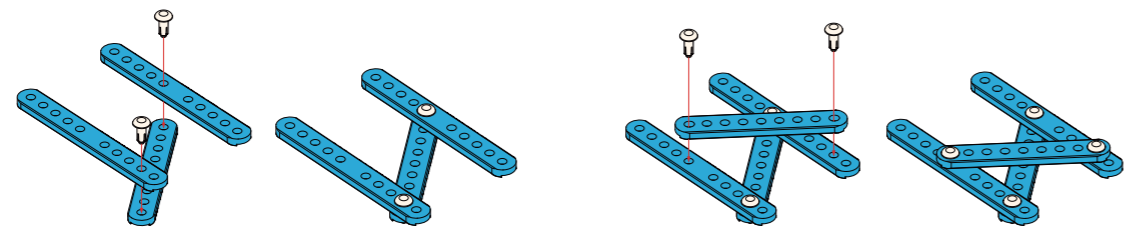

M08 Assembly Instructions 搭建步骤

- 4x  ⑤
- 4x  ⑥
- 8x  ②⑧
- 2x  ③①
- 2x  ③⑤



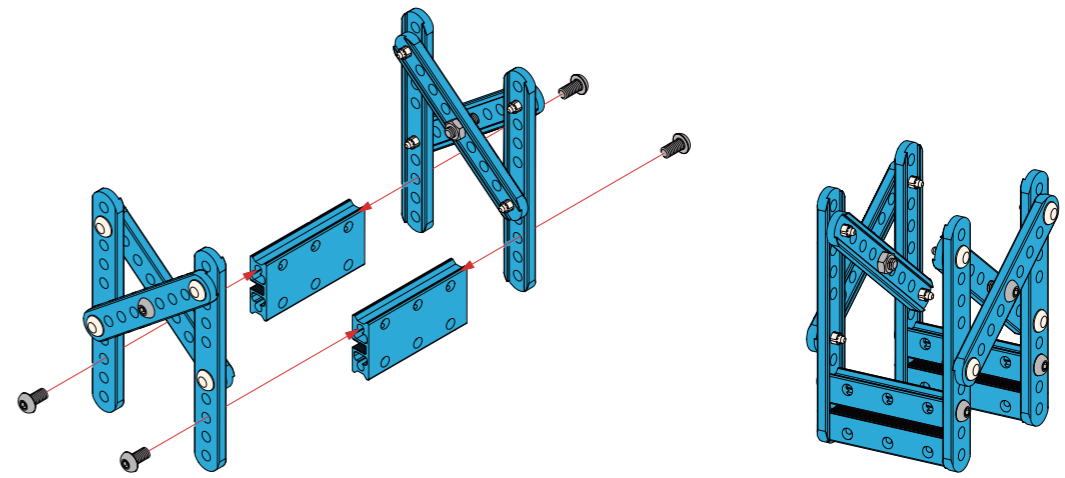

M08 Assembly Instructions 搭建步骤

- 2x  ①
- 4x  ③①



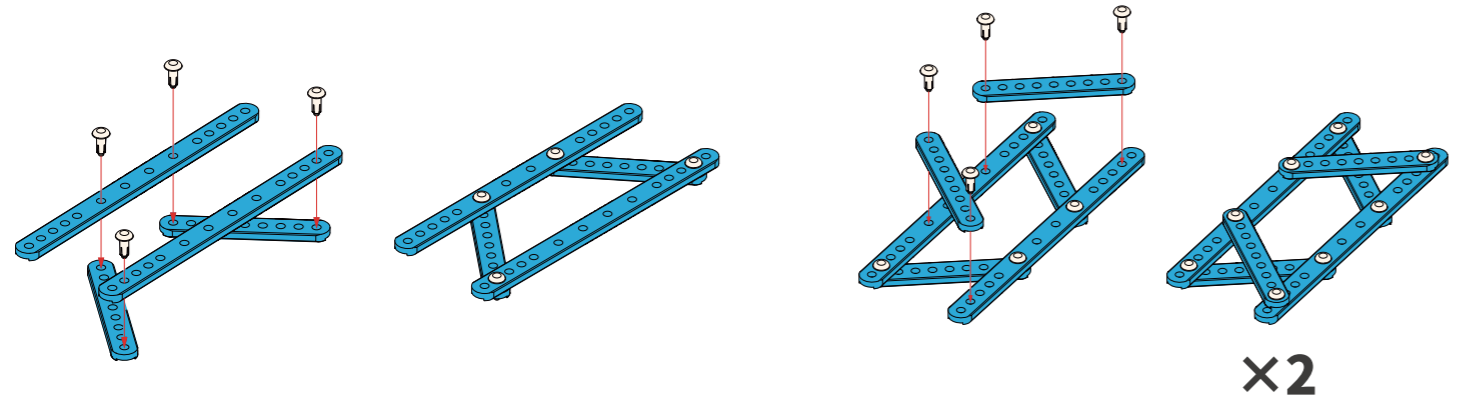

M09 Assembly Instructions 搭建步骤

- 4x  ⑦
- 8x  ⑤
- 16x  ⑳





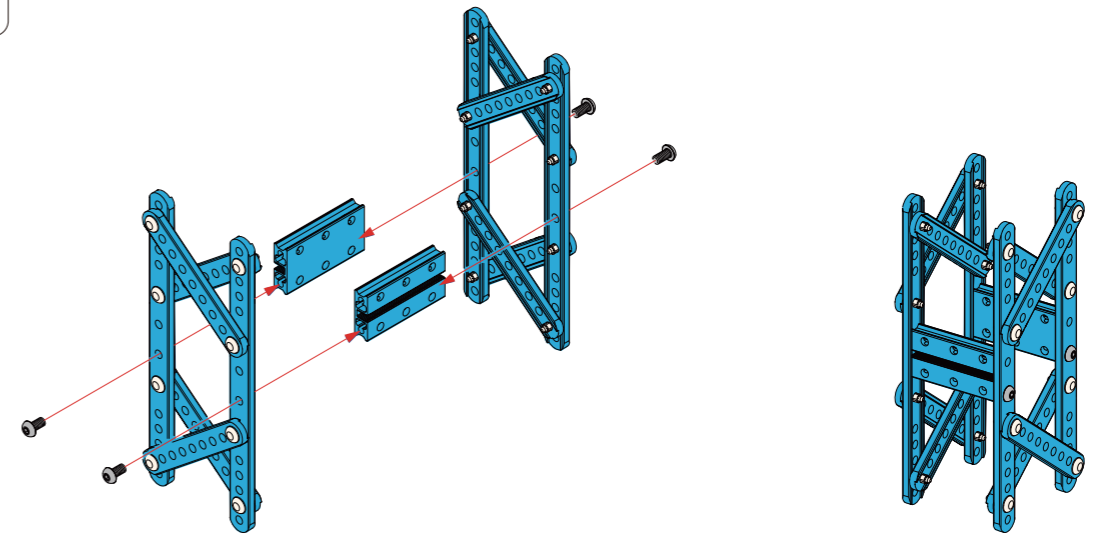

M09 Assembly Instructions 搭建步骤

- 2x  ①
- 4x  ⑳



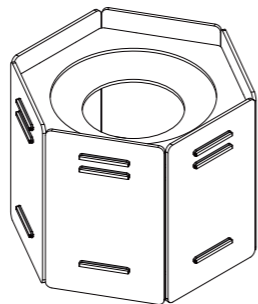
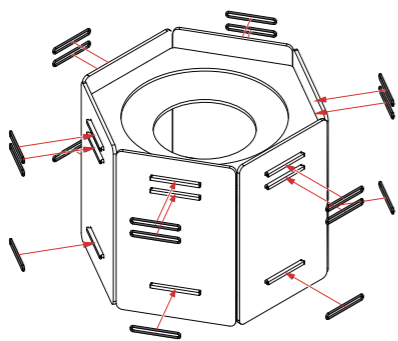
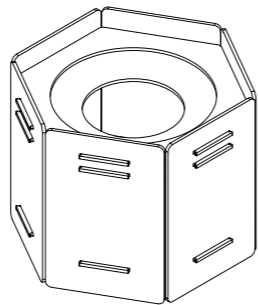
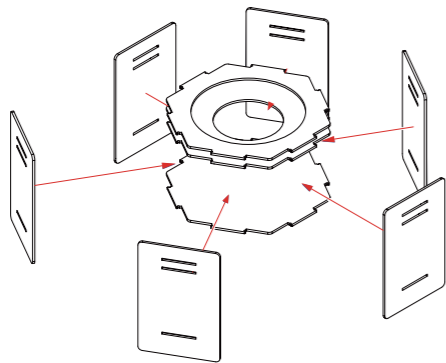

M10 Assembly Instructions 搭建步骤

- 18x  (49)
- 6x  (52)
- 1x  (53)
- 1x  (54)
- 1x  (55)



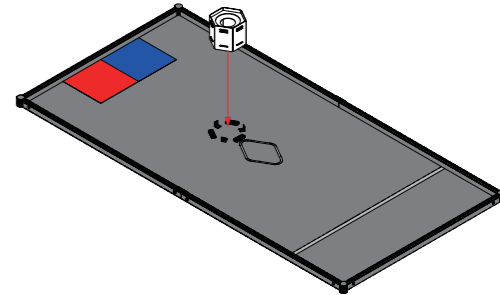
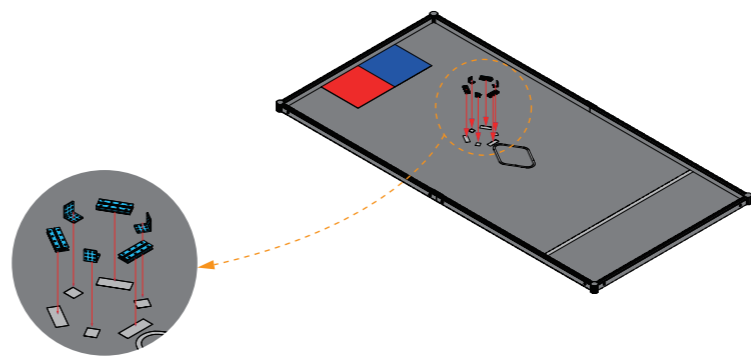
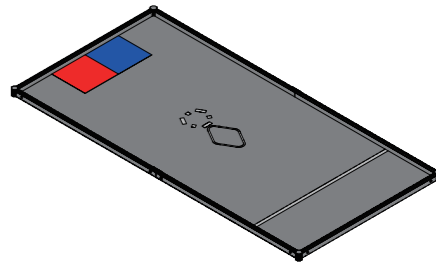
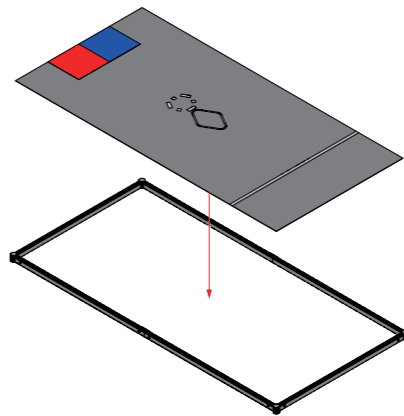

Manual Stage Props Placement 手动场地道具摆放

- 3x  (2)
- 3x  (13)
- 1x  (51)



Manual Stage Props Placement 手动场地道具摆放

- 30x  (41)
- 1x  (56)
- 1x  (48)

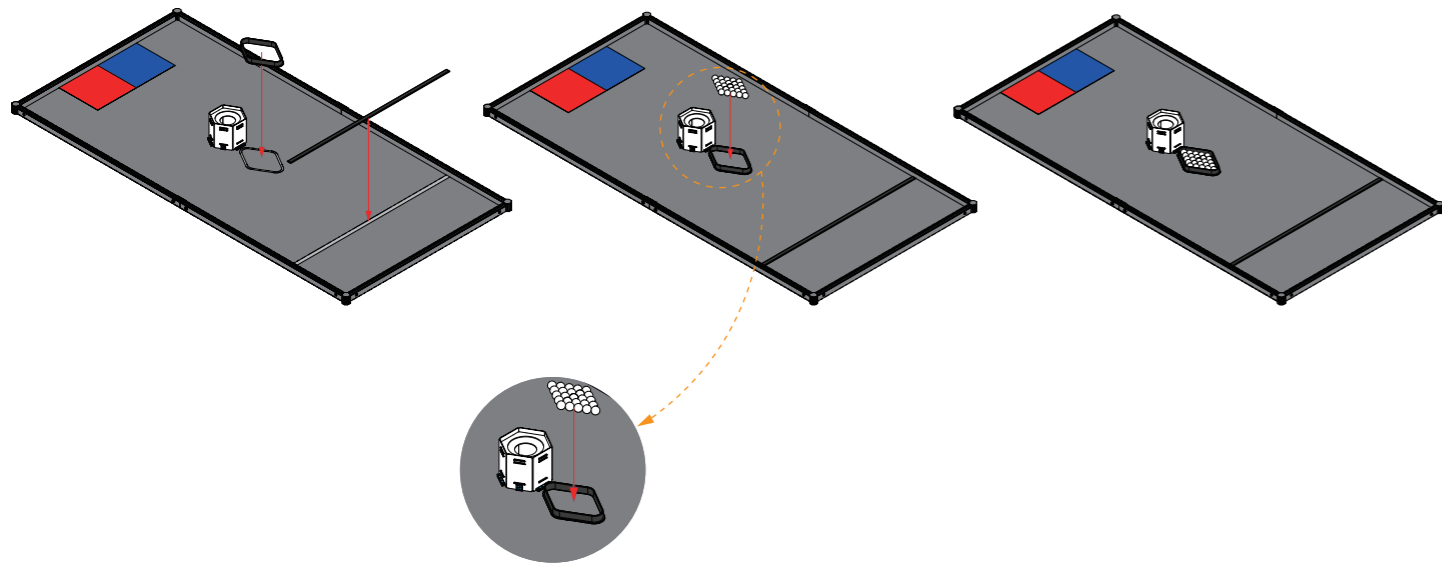

道具摆放位置仅供参考, 实际情况以比赛任务说明为准。

The location of prop is for reference only. Please find the details of location in the mission description.

